

CABINA FLEXY
FLEXY WALK-IN CLOSET



scheda tecnica data sheet

STRUTTURA / FRONTALI – FINITURE COLORI

EXTERNAL FINISHES / FRONTS – FINISHES AND COLOURS

Fascia 1 Price range 1

finitura liscia plain finish

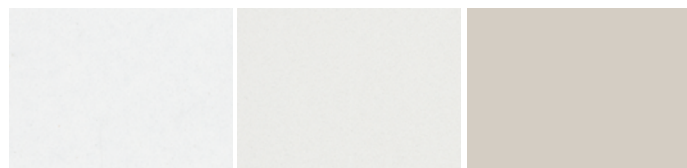

bianco talco
talc white

pomice
pumice

cashmere

Fascia 2 Price range 2

finitura liscia plain finish

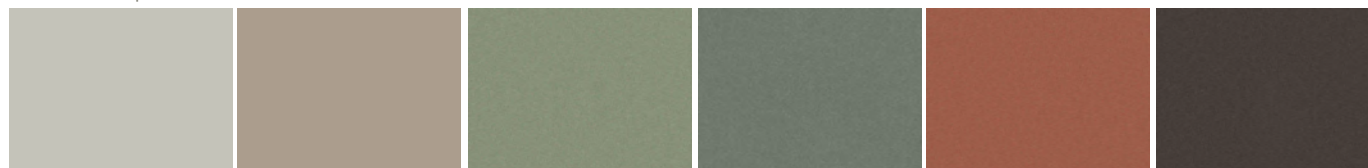

arena

selce
flint

agave

ottanio
octane

terracotta

lava

finiture materiche textured finishes

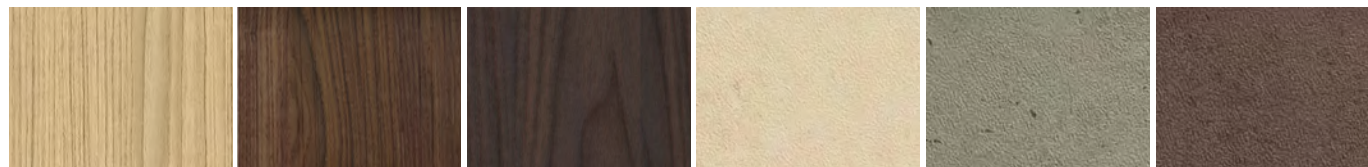

rovere natural
natural oak

noce
walnut

lignum dark

opus calce
opus lime

opus cemento
opus concrete

opus mattone
opus brick

Fascia 2 – finiture disponibili solo per schiene librerie FREESPACE

Price range 2 – available finishes only for FREESPACE bookcase back panels

finiture materiche textured finishes

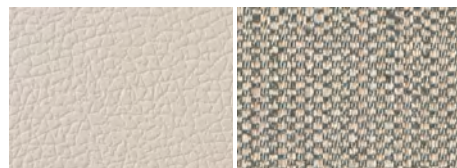

cretto cashmere

cocò

I nuovi colori Agave, Terracotta e Lava sono disponibili per:

- tutti gli elementi in melaminico
- maniglie tipo R, tipo F, BENCH, SHANGHAI, tipo M, RULER, VIRGOLA (da pag. 12 a pag. 25)
- maniglie a profilo GOLA e GRIP con le medesime maggiorazioni previste per i colori di fascia 2 (pag. 27-28)
- pensili LINEA con le medesime maggiorazioni previste per i colori di fascia 2 (pag. 164-165)

New finishes Agave, Terracotta and Lava are available for:

- all the melamine elements
- type R, type F, BENCH, SHANGHAI, type M, RULER, VIRGOLA handles (from page 12 to page 25)
- handles and profiles GOLA and GRIP with the same price increase of the colors in price range 2 (pages 27-28)
- LINEA hanging elements with the same price increase of the colors in price range 2 (pages 164-165)

CABINA FLEXY
FLEXY WALK-IN CLOSET

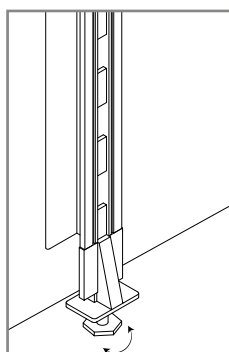
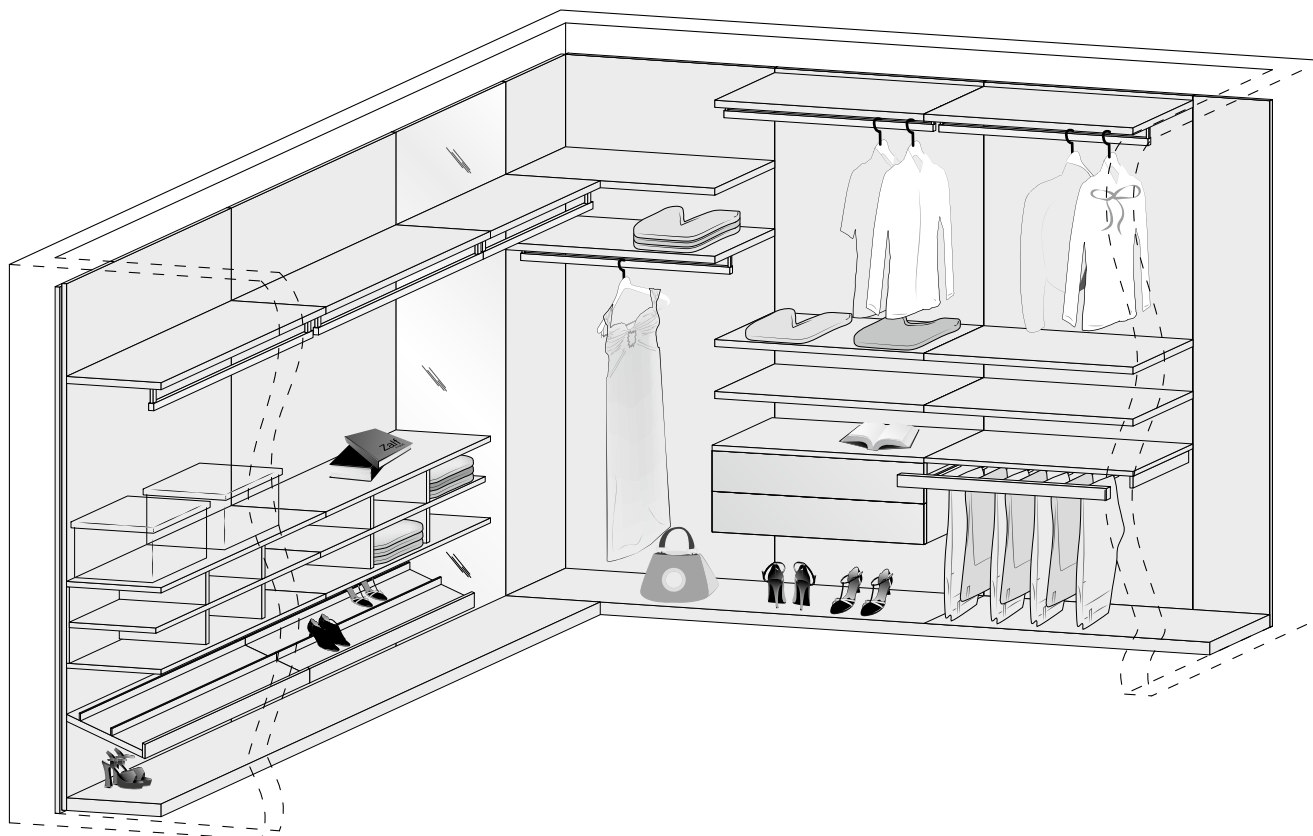

Profilo cremagliera attrezzato di piedino regolabile
H. min 0.6 max 1.8

Rack profile equipped with adjustable foot
H. min 0.6 max 1.8

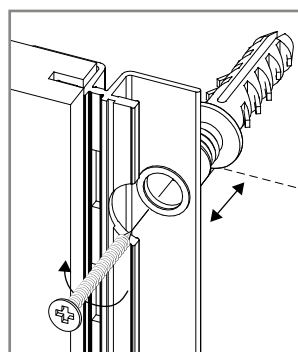

Possibilità di regolazione profilo cremagliera in profondità max + 0.8 cm

Rack profile depth adjustment max + 0.8 cm

INFORMAZIONE

Per il fissaggio in sicurezza di questo sistema è importante verificare, preventivamente, l'idoneità della parete di resistere alle forze/peso che vanno a gravare sulla stessa.

La portata massima delle mensole/ripiani è di 20 kg per metro lineare.

INFORMATION

Before applying this system, check that the wall to which it will be attached is suitable for the strain/weight it will have to carry.

Max capacity of shelves is 20 kg per lin. metre.

INFORMAZIONI UTILI PER IL MONTAGGIO

Lo spazio necessario per il montaggio:

- Ⓐ + 1.5 cm in larghezza con utilizzo profilo terminale L. 3.3 cm
- + 1 cm in altezza

USEFUL INFORMATION FOR THE ASSEMBLY

The necessary space for the assembly:

- Ⓐ + 1.5 cm in width with use of end profile W. 3.3 cm
- + 1 cm in height

FERRAMENTA IN DOTAZIONE

Tasselli universali ø 6 mm in nylon con vite

STANDARD HARDWARE

Universal dowels ø 6 mm in nylon with screw

CABINA FLEXY FLEXY WALK-IN CLOSET



ALTEZZE | HEIGHTS

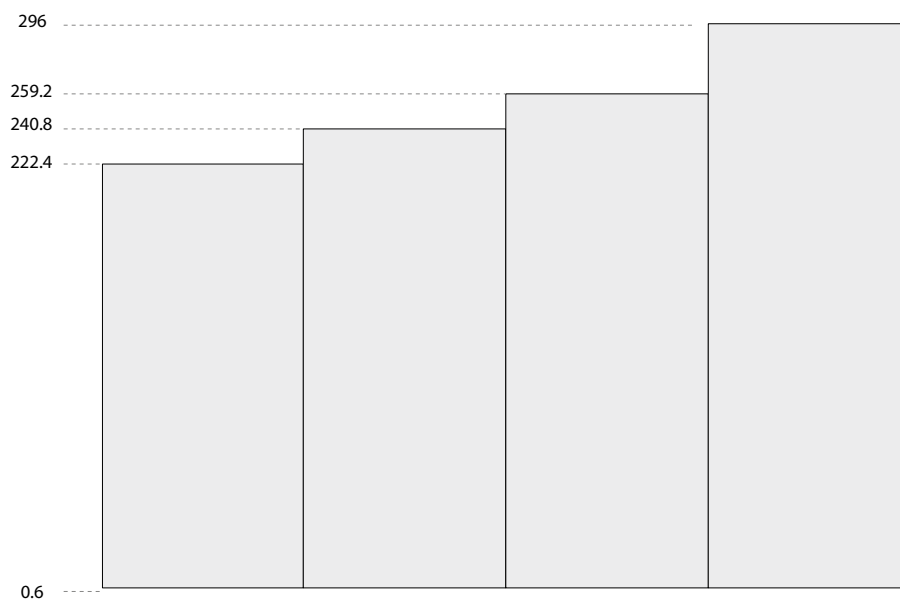

LARGHEZZE | WIDTHS

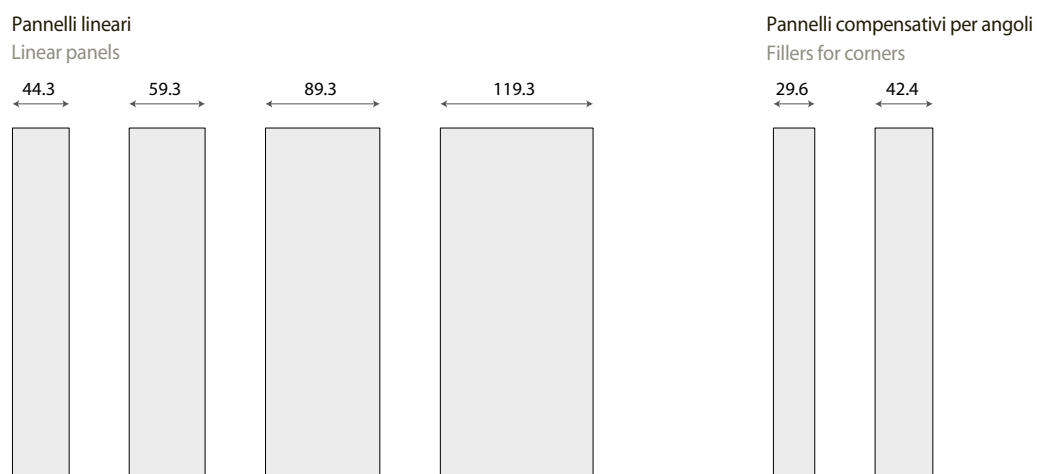

PROFONDITÀ | DEPTHS

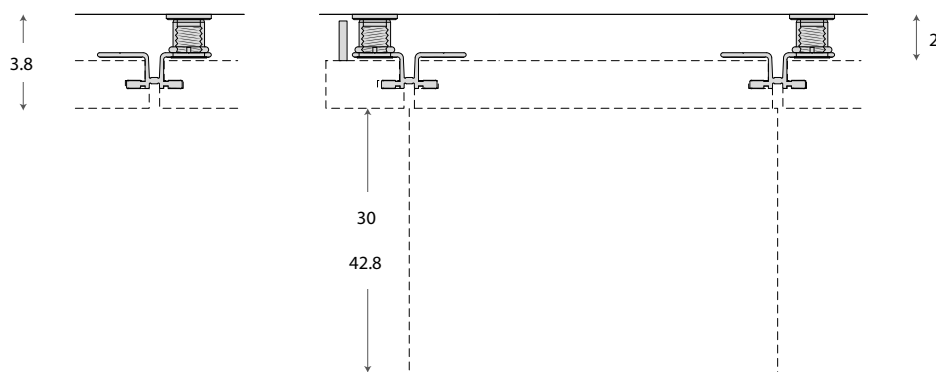

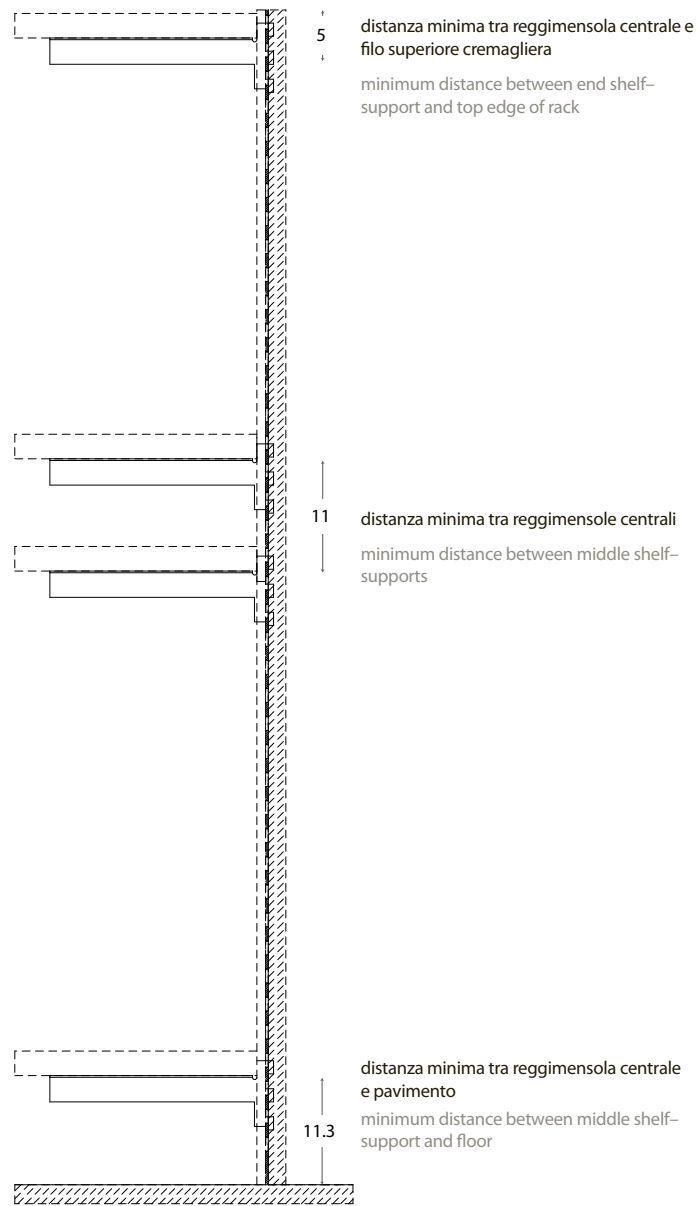
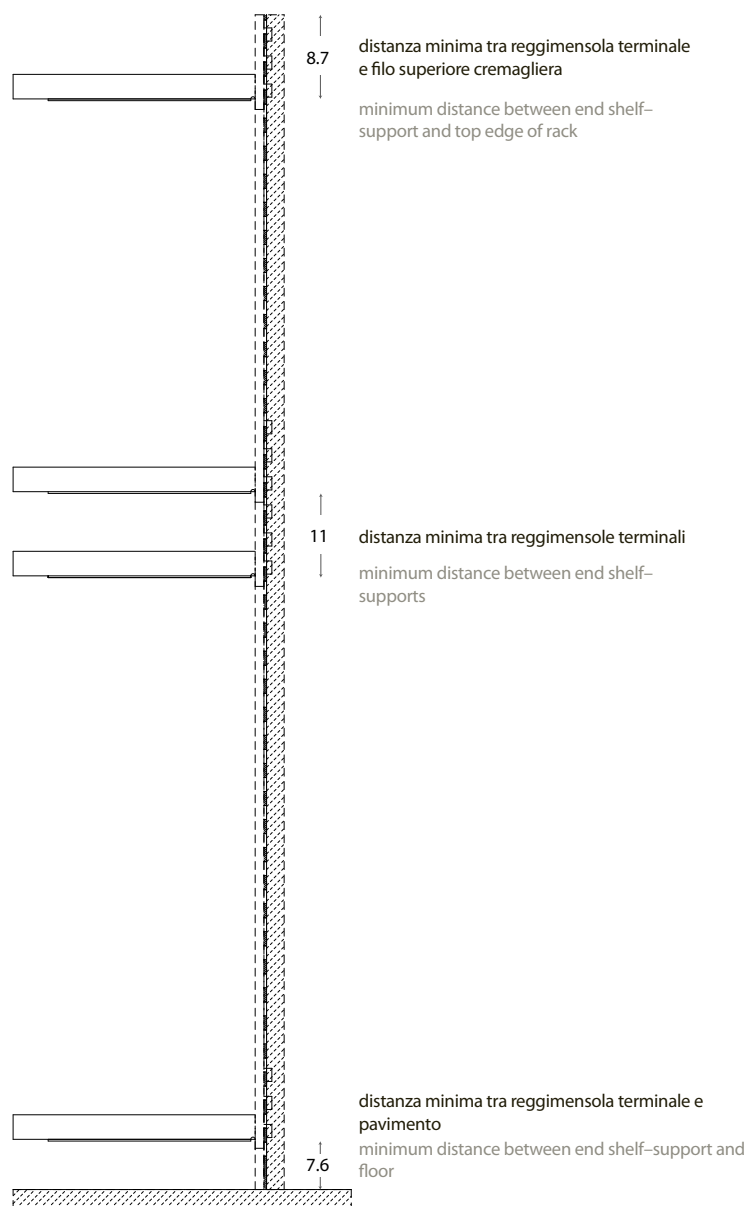

la foratura del profilo cremagliera, dotata di piedini regolabili in altezza, è in passo 3.68 cm

the drilling of rack profile, fitted with height adjustable feet, has pitch 3.68 cm

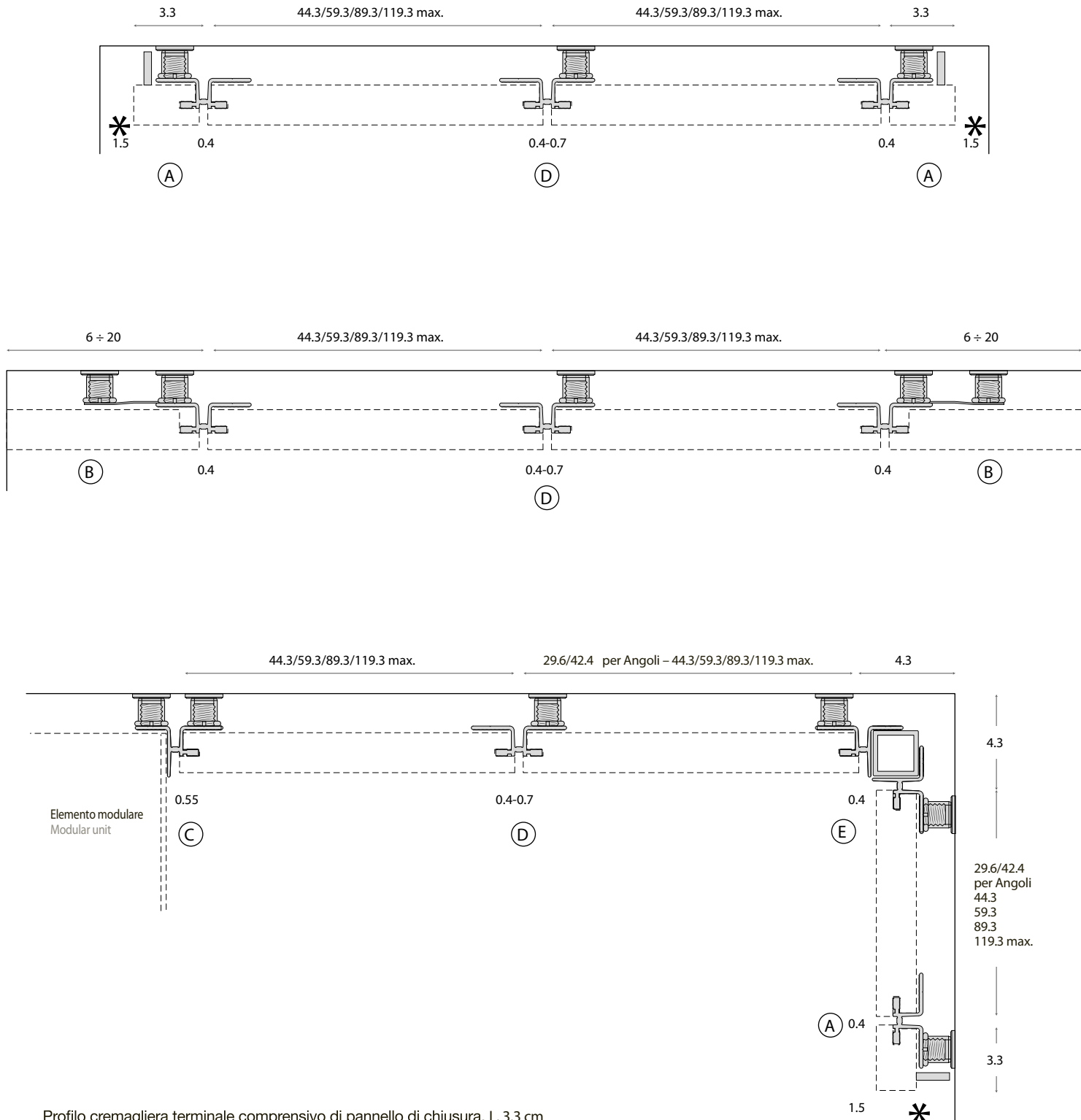

- (A) Profilo cremagliera terminale comprensivo di pannello di chiusura. L. 3.3 cm
End rack profile with closing panel. W. 3.3 cm
 - (B) Profilo cremagliera terminale comprensivo di ferramenta per fissaggio e pannello di aggiustaggio L. 6 ÷ 20 cm
End rack profile with fixing hardware and adjustment panel L. 6 ÷ 20 cm
 - (C) Profilo cremagliera terminale per accosto elementi modulari.
End rack profile for side by side modular elements.
 - (D) Profilo cremagliera centrale L. 0.4 per 1 supporto L. 0.7 per 2 supporti.
Central rack profile W. 0.4 for 1 support W. 0.7 for 2 supports.
 - (E) Profilo cremagliera per soluzione ad angolo.
Rack profile for corner solution.
- * Spazio libero per il montaggio del pannello di chiusura sul profilo cremagliera terminale. (A)
Free space for the assembly of closing panel on end rack profile.