

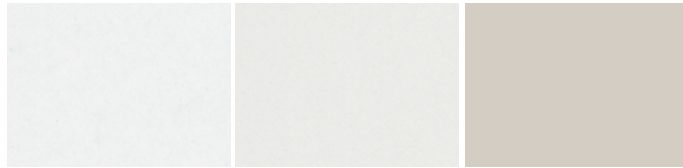

Fascia 1 Price range 1

finitura liscia plain finish



bianco talco  
talc white

pomice  
pumice

cashmere

Fascia 2 Price range 2

finitura liscia plain finish

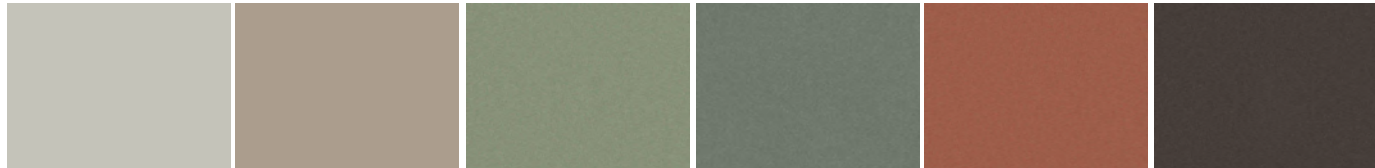

arena

selce  
flint

agave

ottanio  
octane

terracotta

lava

finiture materiche textured finishes

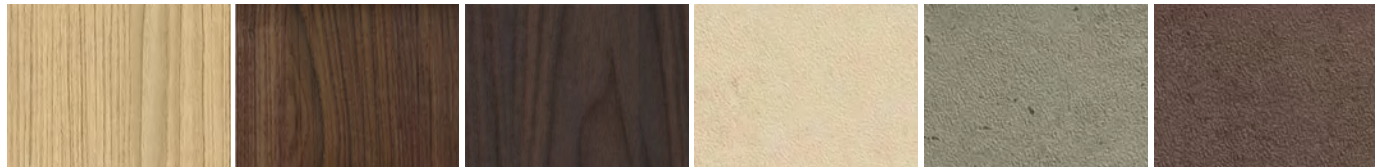

rovere natural  
natural oak

noce  
walnut

lignum dark

opus calce  
opus lime

opus cemento  
opus concrete

opus mattone  
opus brick

Fascia 2 – finiture disponibili solo per schiene librerie FREESPACE

Price range 2 – available finishes only for FREESPACE bookcase back panels

finiture materiche textured finishes

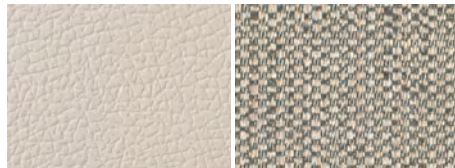

cretto cashmere

cocò

I nuovi colori Agave, Terracotta e Lava sono disponibili per:

- tutti gli elementi in melaminico
- maniglie tipo R, tipo F, BENCH, SHANGHAI, tipo M, RULER, VIRGOLA (da pag. 12 a pag. 25)
- maniglie a profilo GOLA e GRIP con le medesime maggiorazioni previste per i colori di fascia 2 (pag. 27-28)
- pensili LINEA con le medesime maggiorazioni previste per i colori di fascia 2 (pag. 164-165)

New finishes Agave, Terracotta and Lava are available for:

- all the melamine elements
- type R, type F, BENCH, SHANGHAI, type M, RULER, VIRGOLA handles (from page 12 to page 25)
- handles and profiles GOLA and GRIP with the same price increase of the colors in price range 2 (pages 27-28)
- LINEA hanging elements with the same price increase of the colors in price range 2 (pages 164-165)

BASI A TERRA / APPOGGIO / SOSPESE  
FLOOR-STANDING / RAISED / SUSPENDED BASE UNITS



**CONTENITORI**

BASI A TERRA / APPOGGIO / SOSPESE  
FLOOR-STANDING / RAISED / SUSPENDED BASE UNITS

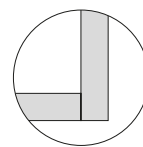

SP.18 MM  
18 MM THICK



**UNOEDUE**

BASI APPOGGIO / SOSPESE  
RAISED / SUSPENDED BASE UNITS

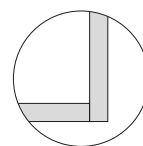

UNOEDUE  
BASI SP.12 MM  
BASE UNIT WITH  
12 MM THICK

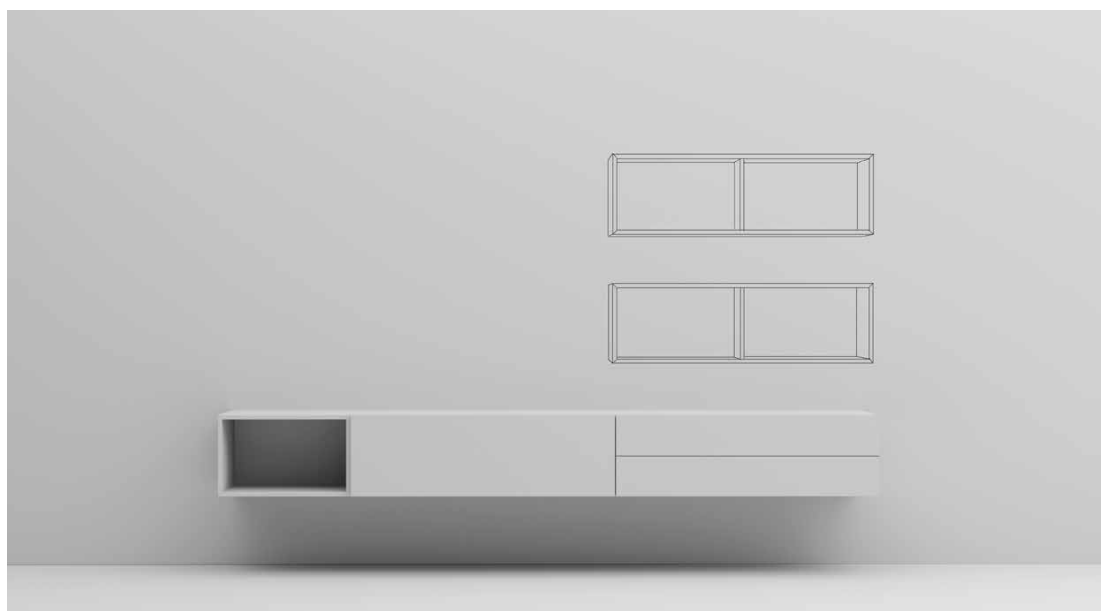

**Z45**

BASI SOSPESE  
SUSPENDED BASE UNITS

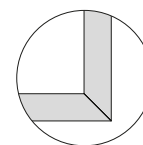

Z45  
BASI UNIONE 45°  
BASE UNIT WITH 45°  
JOINTS

ALTEZZE BASI A TERRA | FLOOR-STANDING BASE UNIT HEIGHTS

Top di finitura sp. 1.2 cm o sp. 2.8 cm necessario  
Finishing top th. 1.2 cm or th. 2.8 cm necessary

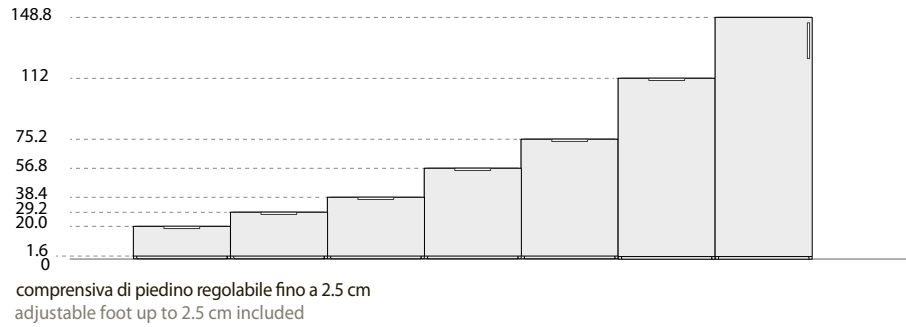

ALTEZZE BASI IN APPOGGIO O SOSPESSE | RAISED OR SUSPENDED BASE UNIT HEIGHTS

Top di finitura sp. 1.2 cm o sp. 2.8 cm necessario  
Finishing top th. 1.2 cm or th. 2.8 cm necessary

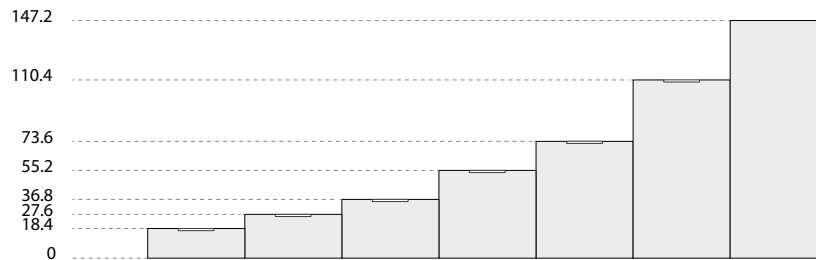

LARGHEZZE BASI | BASE UNIT WIDTHS

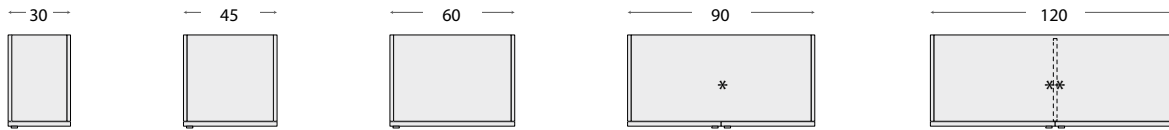

- \* Per i contenitori L. 90 è disponibile a richiesta una barra di rinforzo su cappello.
- \*\* I contenitori L. 120 cm con anta sono dotati di tramezza. Quelli con cassetti, invece, sono dotati di serie di barra di rinforzo sul cappello.
- \* For storage units W. 90 a reinforcement bar on top is available upon request
- \*\* Storage units W. 120 cm with door are fitted with partition. Storage units with drawers are fitted as standard with a reinforcement bar on top.

LARGHEZZE DISPONIBILI SOLO PER BASI CON ANTA RIBALTA H. 18.4 / 27.6 / 36.8 CM Dotati di tramezza

WIDTHS AVAILABLE ONLY FOR BASE UNITS WITH FLAP DOOR H. 18.4 / 27.6 / 36.8 CM Fitted with partition

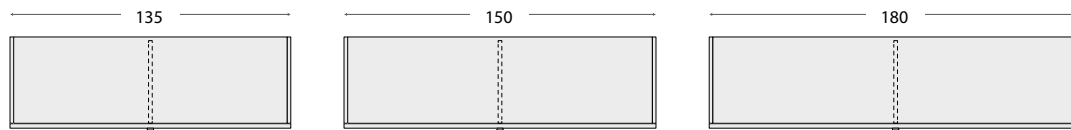

PROFONDITÀ BASI | BASE UNIT DEPTHS

ANTE PLANA E GOLA | PLANA and GOLA DOORS

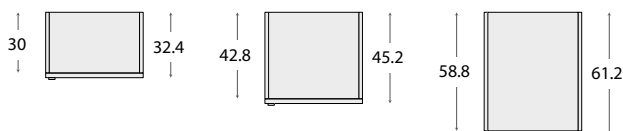

ANTE CITY GLASS | CITY GLASS DOORS

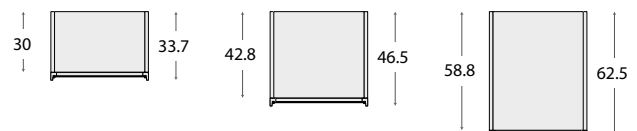

LARGHEZZE e PROFONDITÀ BASI TERMINALI | END BASE UNIT WIDTHS and DEPTHS

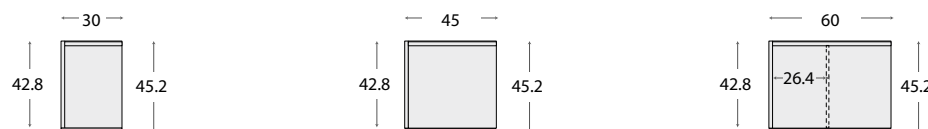

# CONTENITORI BASI STORAGE BASE UNITS

## ALTEZZE BASI A TERRA

Top di finitura Sp. 1.2 cm o Sp. 2.8 cm necessario fino H. 148.8 cm

## FLOOR-STANDING BASE UNIT HEIGHTS

Top th. 1.2 cm or th. 2.8 cm must be included on heights up to 148.8 cm

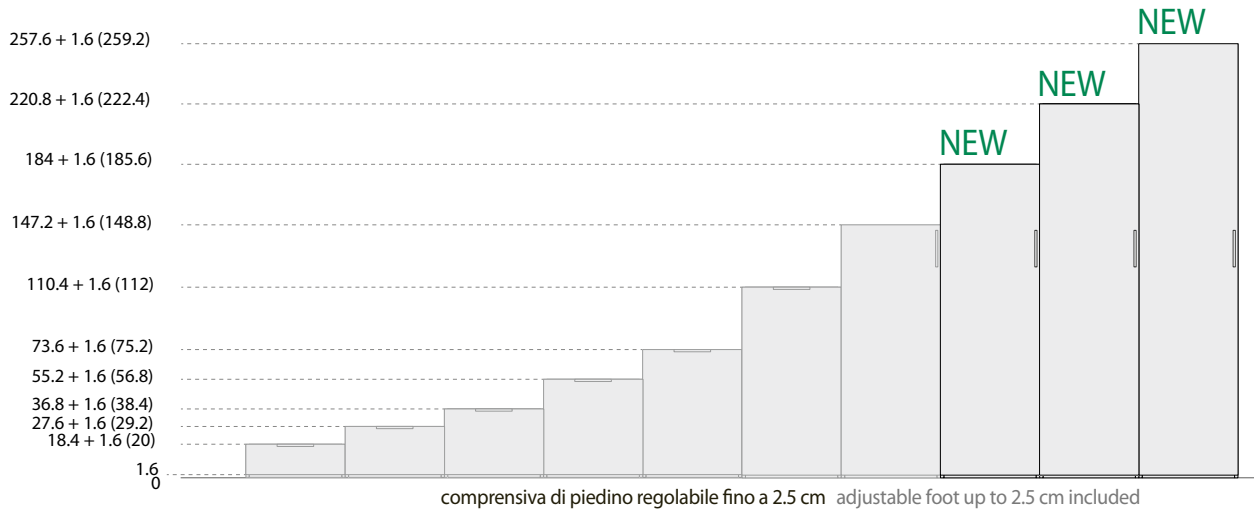

## ALTEZZE BASI IN APPOGGIO

Top di finitura Sp. 1.2 cm o Sp. 2.8 cm necessario fino H. 148.8 cm

## RAISED BASE UNIT HEIGHTS

Top th. 1.2 cm or th. 2.8 cm must be included on heights up to 148.8 cm

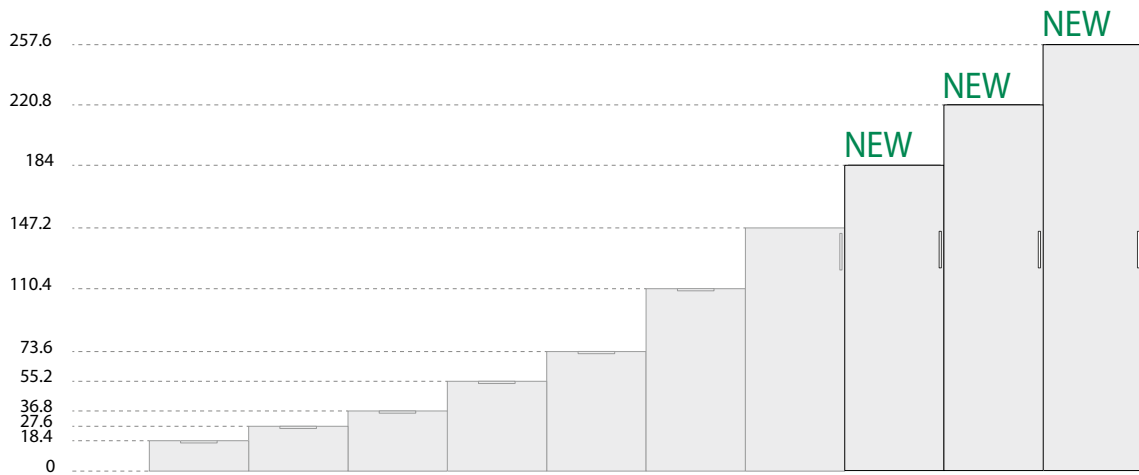

## LARGHEZZE BASI

Per altezze 184-220.8-257.6 cm

## BASE UNIT WIDTHS

For H. 184 - 220.8 - 257.6 cm

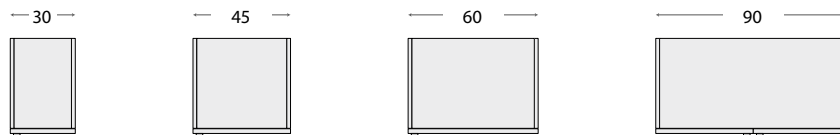

## PROFONDITÀ BASI

Per altezze 184-220.8-257.6 cm

## BASE UNIT DEPTHS

For H. 184 - 220.8 - 257.6 cm

### ANTE PLANA E GOLA PLANA and GOLA DOORS

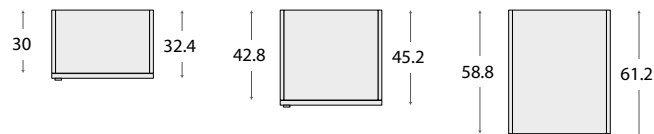

**BASI CONTENITORI CON ANTA SPORGENTE**  
**BASE UNITS WITH PROTRUDING DOOR**

**ALTEZZE BASI A TERRA FLOOR-STANDING BASE UNIT HEIGHTS**

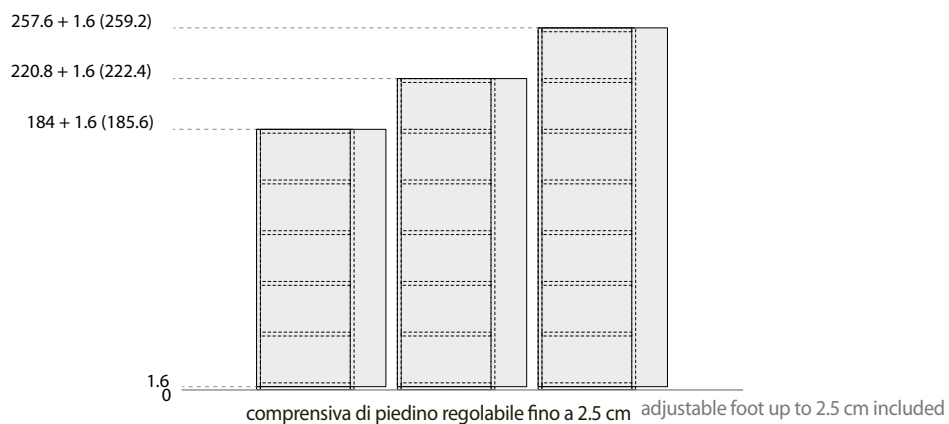

**ALTEZZE BASI IN APPOGGIO RAISED BASE UNIT HEIGHTS**

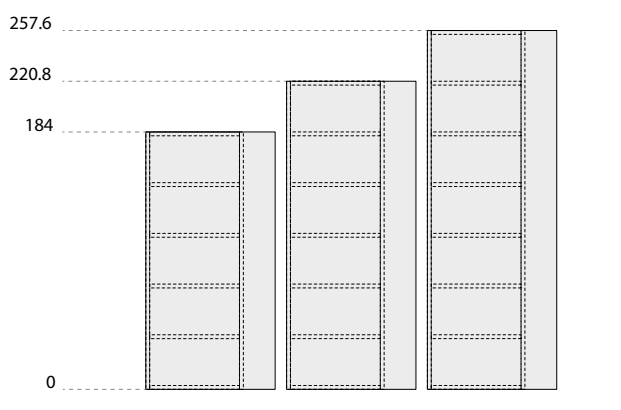

**LARGHEZZE BASI BASE UNIT WIDTHS**

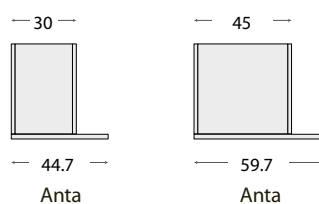

**PROFONDITÀ BASI BASE UNIT DEPTHS**

**ANTE PLANA PLANA DOORS**

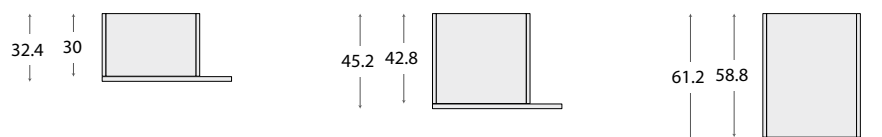

# UNOEDUE BASI IN APPOGGIO E SOSPENSE

## UNOEDUE RAISED / SUSPENDED BASE UNITS



ALTEZZE BASI | BASE UNIT HEIGHTS

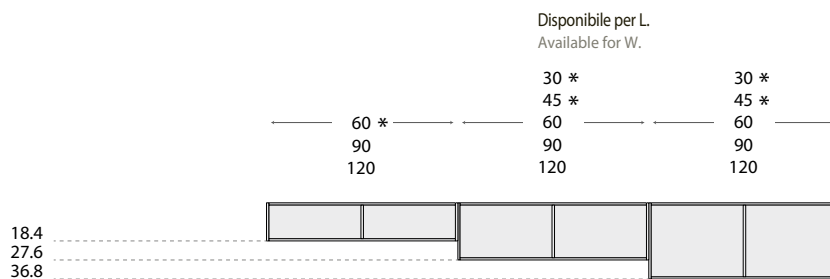

\* senza tramezza without partitions

LARGHEZZE BASI | BASE UNIT WEIGHTS

IN APPOGGIO  
RAISED

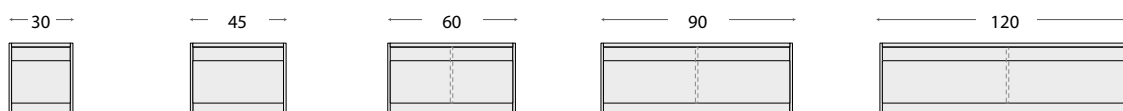

Disponibile per H.  
Available for H.

Width (W)	Height (H)
30	27.6
45	27.6
60	18.4 * 27.6
90	18.4 27.6
120	18.4 27.6

SOSPESO  
SUSPENDED

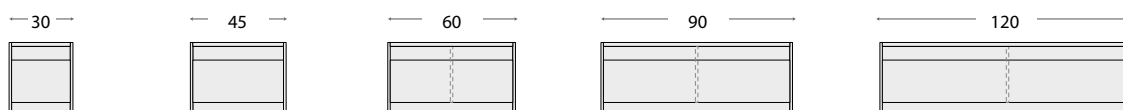

Disponibile per H.  
Available for H.

Width (W)	Height (H)
30	27.6 36.8
45	27.6 36.8
60	27.6 36.8
90	27.6 36.8
120	27.6 36.8

\* senza tramezza without partitions

PROFONDITÀ BASI | BASE UNIT DEPTHS



# Z45 BASI SOSPESE

## Z45 SUSPENDED BASE UNITS



ALTEZZE BASI SOSPESE | SUSPENDED BASE UNIT HEIGHTS

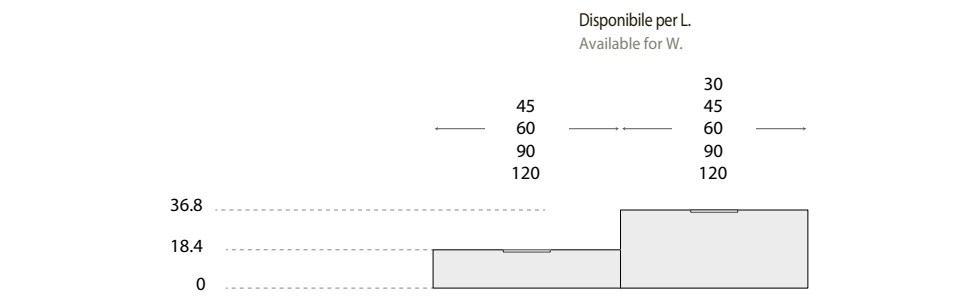

LARGHEZZE BASI SOSPESE | SUSPENDED BASE UNIT WIDTHS

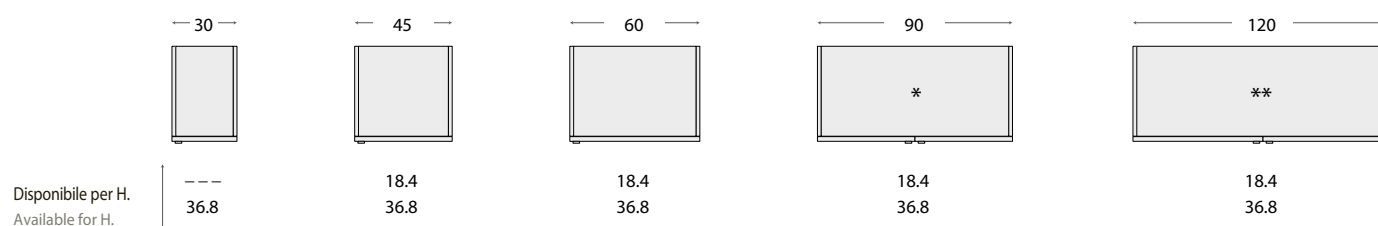

\* Per i contenitori L. 90 è disponibile a richiesta una barra di rinforzo su cappello.

\*\* I contenitori L. 120 cm con anta sono dotati di tramezza. Quelli con cassetti, invece, sono dotati di serie di barra di rinforzo sul cappello

\* For storage units W. 90 a reinforcement bar on top is available upon request.

\*\* Storage units W. 120 cm with door are fitted with partition. Storage units with drawers are fitted as standard with a reinforcement bar on top.

PROFONDITÀ BASI SOSPESE | SUSPENDED BASE UNIT DEPTHS

ANTE PLANA E GOLA | PLANA and GOLA DOORS



PENSILI  
STORAGE UNITS



scheda tecnica data sheet



CONTENITORI

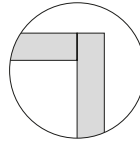

SP.18 MM  
18 MM THICK



UNOEDUE

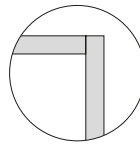

UNOEDUE  
PENSILI SP.12 MM  
WALL UNIT WITH  
12 MM THICK

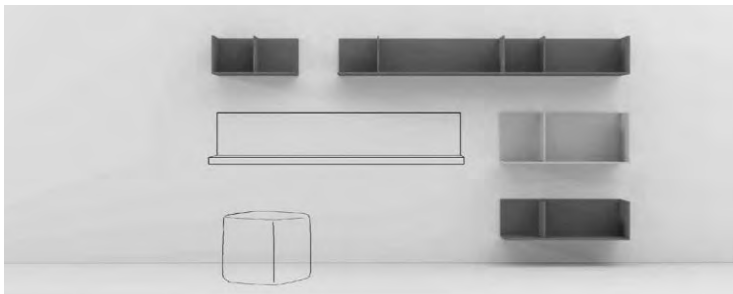

Z45

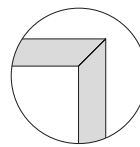

Z45  
PENSILI UNIONE 45°  
WALL UNIT  
WITH 45° JOINTS



VUOTOPIENO

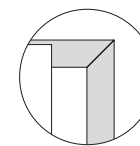

VUOTOPIENO  
PENSILI UNIONE 45°  
ANTE ASIMMETRICHE  
WALL UNITS WITH  
45° JOINTS AND  
ASYMMETRIC FRONTS



## STRUTTURA / FRONTALI – FINITURE COLORI

EXTERNAL FINISHES / FRONTS – FINISHES AND COLOURS

### Fascia 1 Price range 1

finitura liscia plain finish

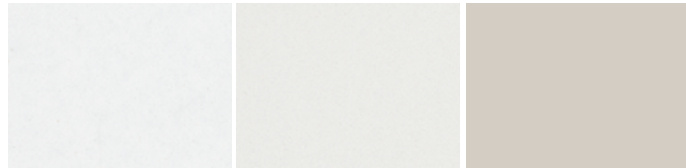

bianco talco  
talc white

pomice  
pumice

cashmere

### Fascia 2 Price range 2

finitura liscia plain finish

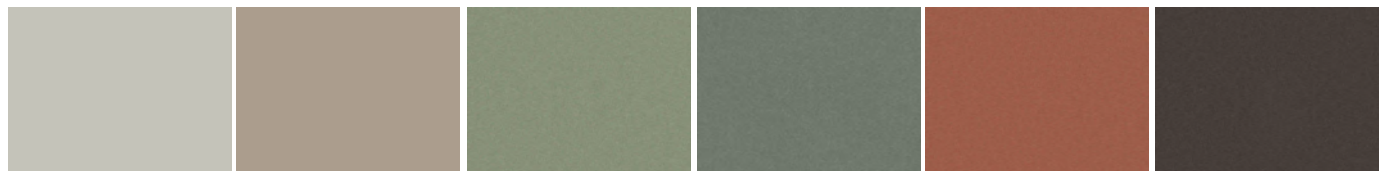

arena

selce  
flint

agave

ottanio  
octane

terracotta

lava

finiture materiche textured finishes

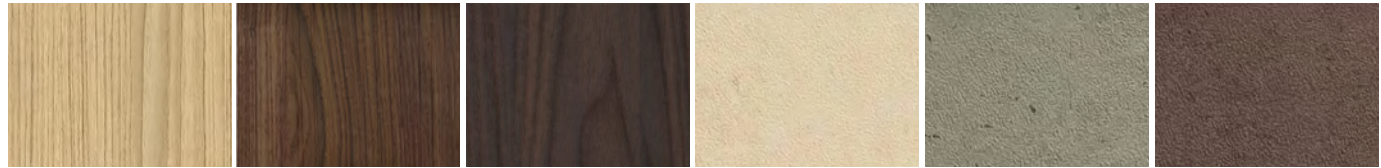

rovere natural  
natural oak

noce  
walnut

lignum dark

opus calce  
opus lime

opus cemento  
opus concrete

opus mattone  
opus brick

### Fascia 2 – finiture disponibili solo per schiene librerie FREESPACE

Price range 2 – available finishes only for FREESPACE bookcase back panels

finiture materiche textured finishes



cretto cashmere

cocò

I nuovi colori Agave, Terracotta e Lava sono disponibili per:

- tutti gli elementi in melaminico
- maniglie tipo R, tipo F, BENCH, SHANGHAI, tipo M, RULER, VIRGOLA (da pag. 12 a pag. 25)
- maniglie a profilo GOLA e GRIP con le medesime maggiorazioni previste per i colori di fascia 2 (pag. 27-28)
- pensili LINEA con le medesime maggiorazioni previste per i colori di fascia 2 (pag. 164-165)

New finishes Agave, Terracotta and Lava are available for:

- all the melamine elements
- type R, type F, BENCH, SHANGHAI, type M, RULER, VIRGOLA handles (from page 12 to page 25)
- handles and profiles GOLA and GRIP with the same price increase of the colors in price range 2 (pages 27-28)
- LINEA hanging elements with the same price increase of the colors in price range 2 (pages 164-165)

ALTEZZE PENSILI | WALL UNIT HEIGHTS

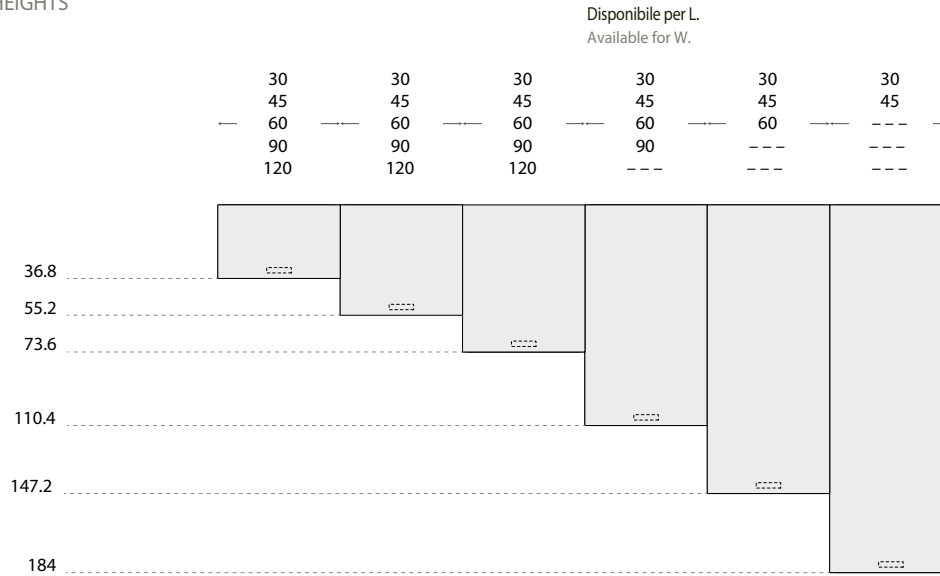

LARGHEZZE PENSILI | WALL UNIT WIDTHS

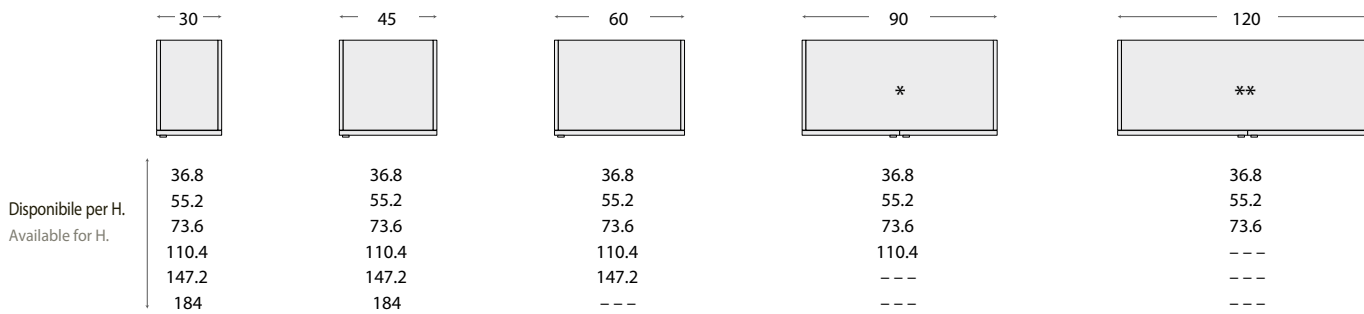

- \* Per i contenitori L. 90 è disponibile a richiesta una barra di rinforzo su cappello.
- \*\* I contenitori L. 120 cm con anta sono dotati di tramezza.
- \* For storage units W. 90 a reinforcement bar on top is available upon request.
- \*\* Storage units W. 120 cm with door are fitted with partition

PROFONDITÀ PENSILI | WALL UNIT DEPTHS

ANTE PLANA E GOLA | PLANA and GOLA DOORS



ANTE CITY GLASS | CITY GLASS DOORS



LARGHEZZE e PROFONDITÀ PENSILI TERMINALI | END WALL UNIT WIDTHS and DEPTHS

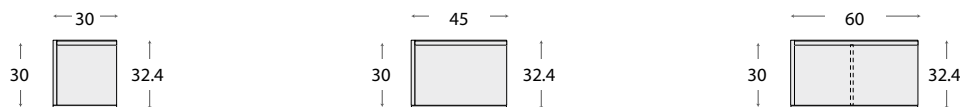

PENSILI CON ANTA SPORGENTE  
 WALL UNIT WITH PROTRUDING DOOR

ALTEZZE PENSILI WALL UNIT HEIGHTS

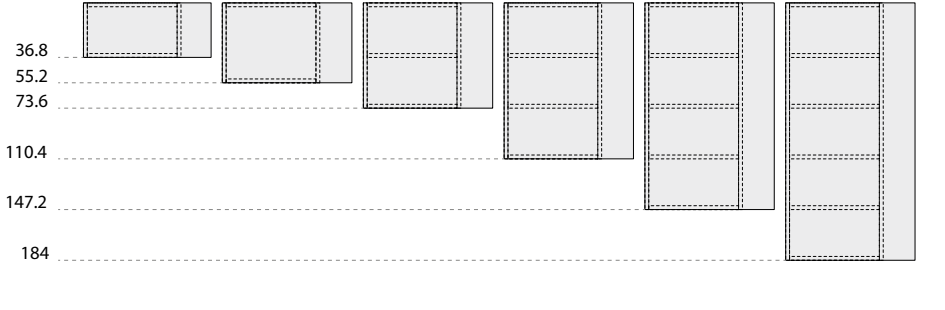

LARGHEZZE PENSILI WALL UNIT WIDTHS

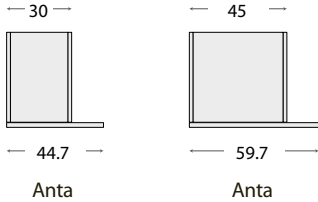

PROFONDITÀ PENSILI WALL UNIT DEPTHS

ANTE PLANA PLANA DOORS



schienale in melaminico Sp. 1.8 cm  
melamine back panel Th. 1.8 cm

fianco in melaminico Sp. 1.2 cm  
melamine side panel Th. 1.8 cm

fondo in melaminico Sp. 1.2 cm  
melamine bottom Th. 1.2 cm

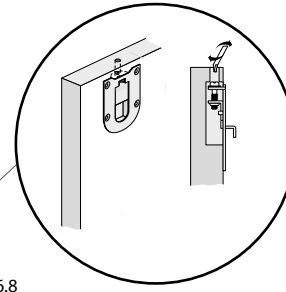
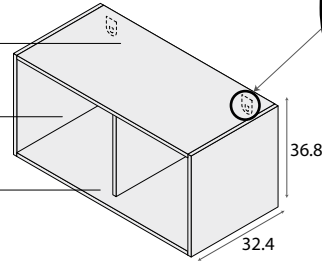

ALTEZZE PENSILI | WALL UNIT HEIGHTS

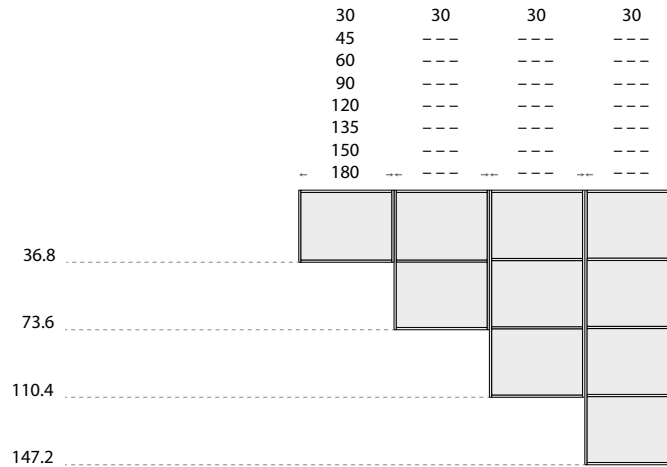

LARGHEZZE PENSILI | WALL UNIT WIDTHS

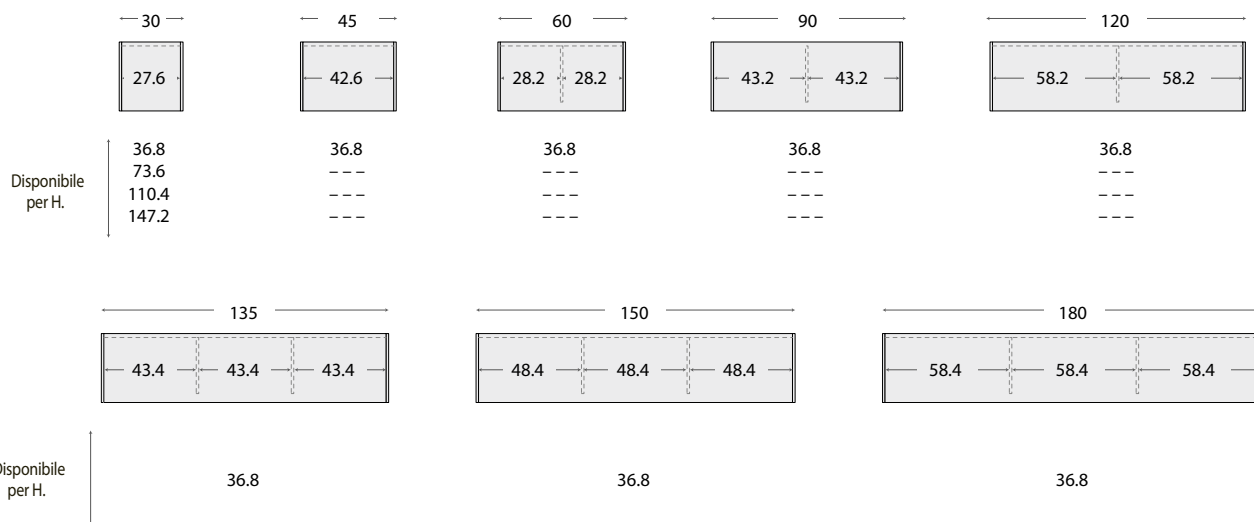

PROFONDITÀ PENSILI | WALL UNIT DEPTHS



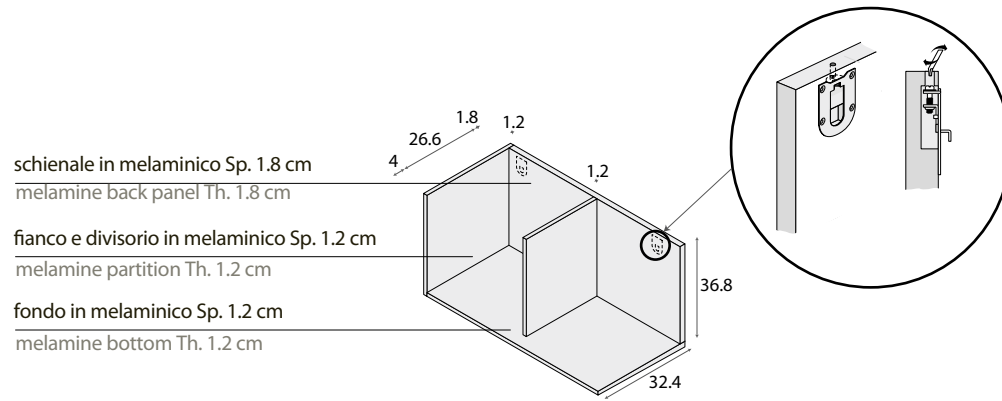

LARGHEZZE PENSILI | WALL UNIT WIDTHS

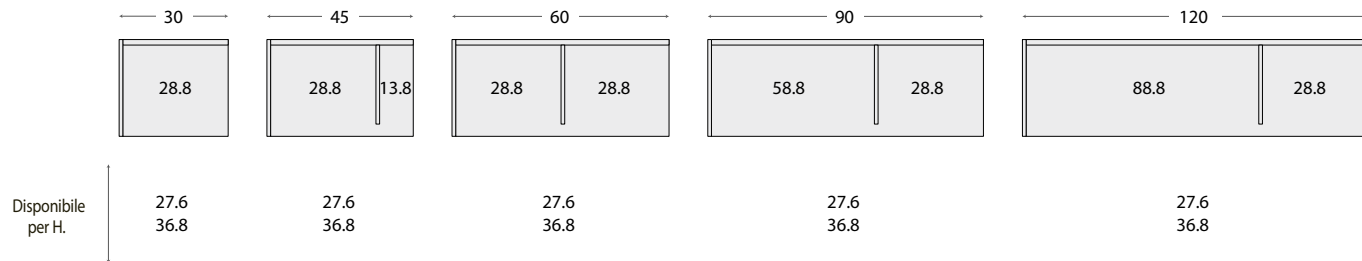

ALTEZZE PENSILI | WALL UNIT HEIGHTS

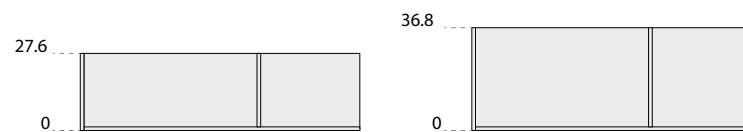

PROFONDITÀ PENSILI | WALL UNIT DEPTHS

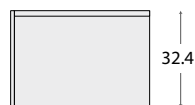

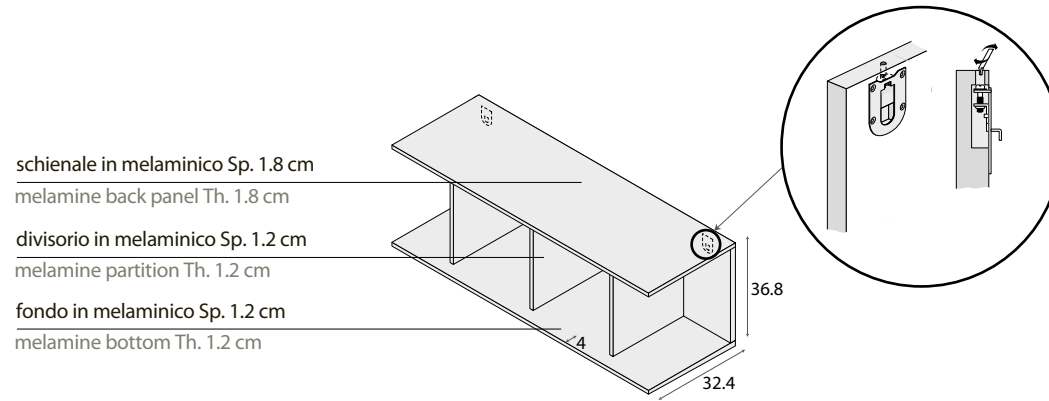

ORIZZONTALI HORIZONTAL

LARGHEZZE PENSILI | WALL UNIT WIDTHS

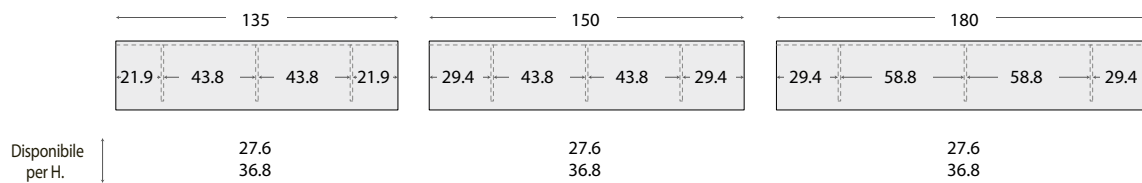

ALTEZZE PENSILI | WALL UNIT HEIGHTS



VERTICALI VERTICAL

LARGHEZZE PENSILI | WALL UNIT WIDTHS

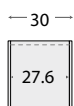

ALTEZZE PENSILI | WALL UNIT HEIGHTS

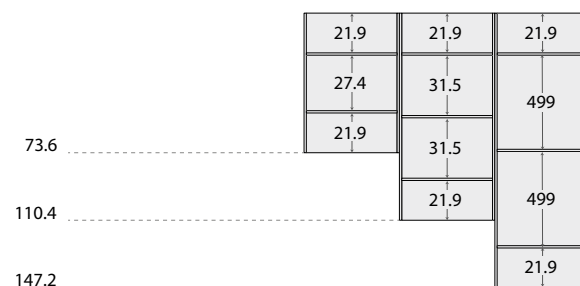

PROFONDITÀ PENSILI | WALL UNIT DEPTHS

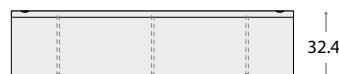

# PENSILI Z45

## Z45 WALL UNITS

ALTEZZE PENSILI | WALL UNIT HEIGHTS

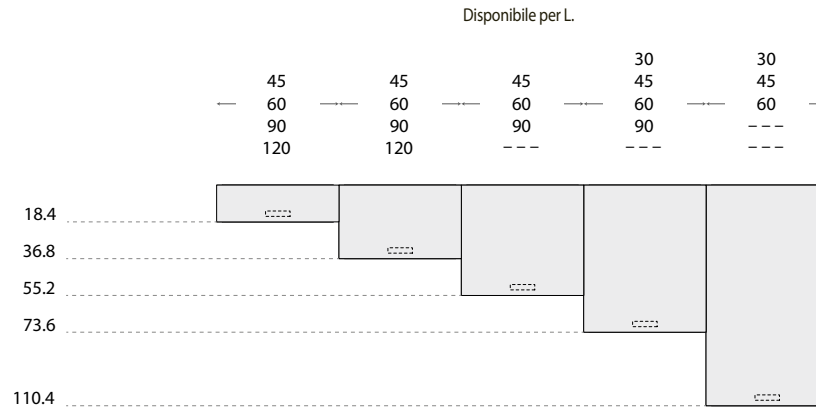

LARGHEZZE PENSILI | WALL UNIT WIDTHS

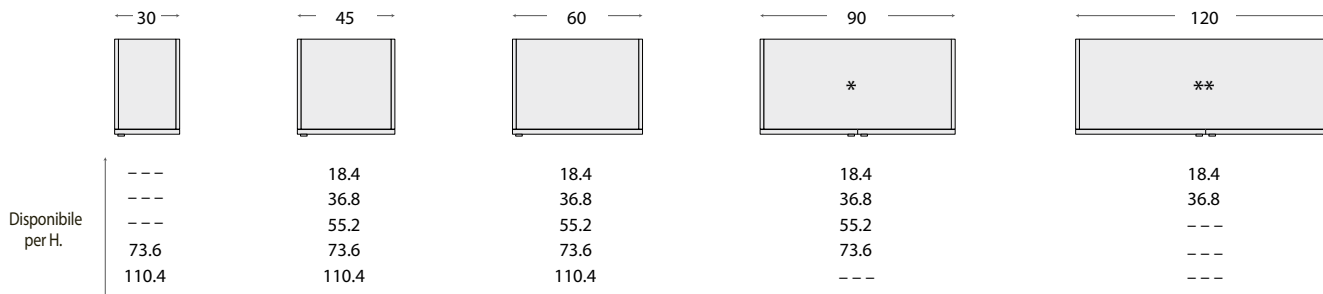

- \* Per i contenitori L. 90 è disponibile a richiesta una barra di rinforzo su cappello.
- \*\* I contenitori L. 120 cm con anta sono dotati di tramezza. Quelli con cassetti, invece, sono dotati di serie di barra di rinforzo sul cappello.
- \* For storage units W. 90 a reinforcement bar on top is available upon request.
- \*\* Storage units W. 120 cm with door are fitted with partition. Storage units with drawers are fitted as standard with a reinforcement bar on top.

PROFONDITÀ PENSILI | WALL UNIT DEPTHS

ANTE PLANA E GOLA | PLANA and GOLA DOORS



# PENSILI VUOTOPIENO VUOTOPIENO WALL UNITS



ALTEZZE PENSILI | WALL UNIT HEIGHTS

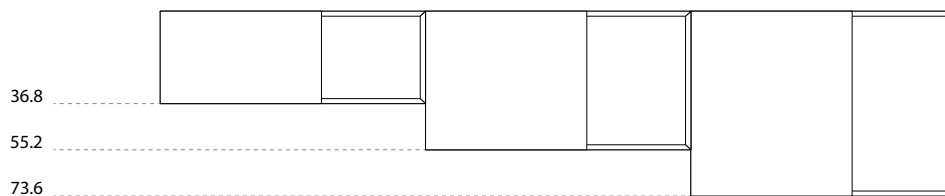

LARGHEZZE PENSILI | WALL UNIT WIDTHS

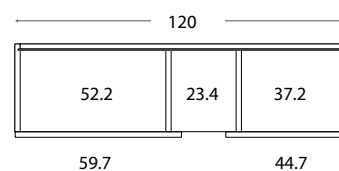
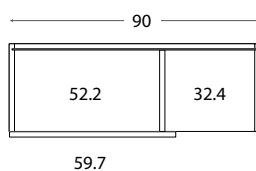
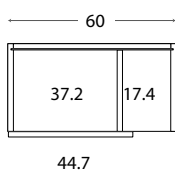
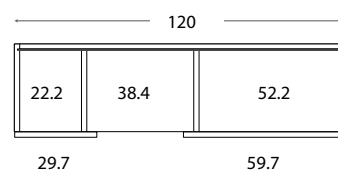
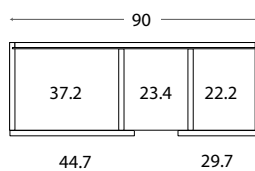
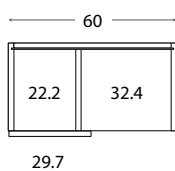
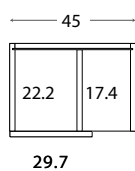

PROFONDITÀ PENSILI | WALL UNIT DEPTHS

ANTE PLANA | PLANA DOORS

