

ARMADI ANTE COMPLANARI - ALTERNA
WARDROBES WITH COPLANAR DOORS - ALTERNA



scheda tecnica data sheet

ESTERNO / FRONTALI - FINITURE COLORI

EXTERNAL FINISHES / FRONTS - FINISHES AND COLOURS

Fascia 1 finitura liscia Price range 1 plain finish

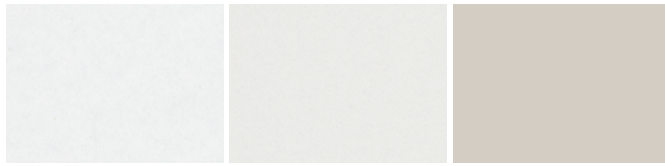

bianco talco
talc white

pomice
pumice

cashmere
cashmere

Fascia 2 finitura liscia Price range 2 plain finish

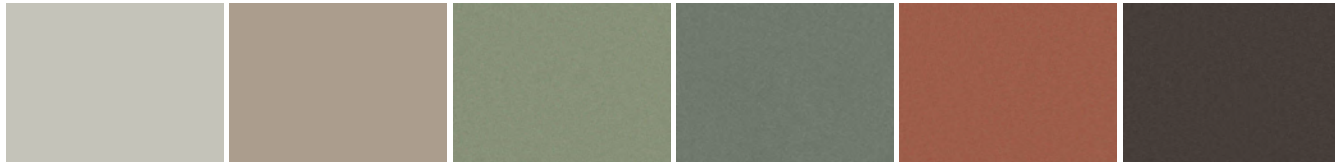

arena
arena

selce
flint

agave

ottanio
octane

terracotta

lava

finitura materica textured finish

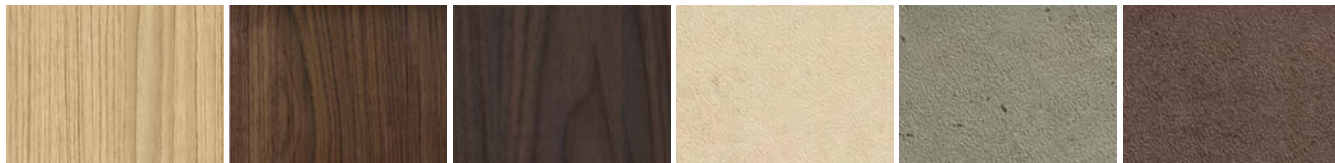

rovere natural
natural oak

noce
walnut

lignum dark

opus calce
opus lime

opus cemento
opus concrete

opus mattone
opus brick

Fascia 2 Solo frontali (esclusi cassetti esterni) e pannelli schienale cabina Flexy

Price range 2 Only fronts (external drawers not included) and back panels for Flexy walk-in closet

finitura materica textured finish



cretto cashmere

cocò

INTERNO / SCOCCA E ATTREZZATURA INTERNA ARMADI ALTERNA
INTERNAL FINISHES / CARCASE AND INTERIOR FITTING FOR ALTERNA WARDROBES

finitura materica textured finish

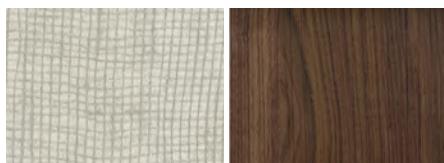

sesamo
sesame

noce
walnut

FIANCHI TERMINALI Sp. 2.5 cm END SIDE PANELS Th. 2.5 cm

Parte interna
Internal part

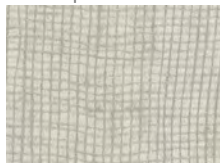

sesamo
sesame

Parte esterna
External part

FASCIA 1
PRICE RANGE 1



bianco talco
talc white

pomice
pumice

cashmere

FASCIA 2
PRICE RANGE 2



arena

selce
flint

agave

ottanio
octane

terracotta

lava

rovere natural
natural oak

lignum dark

opus calce
opus lime

opus cemento
opus concrete

opus mattone
opus brick

Parte interna
Internal part

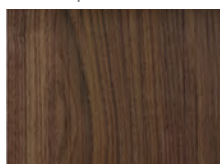

noce
walnut

Parte esterna
External part

FASCIA 1
PRICE RANGE 1



bianco talco
talc white

pomice
pumice

cashmere

FASCIA 2
PRICE RANGE 2



noce
walnut

ANTE A VETRO GLASS DOORS

Ante Glass specchio (dotato di pellicola di sicurezza antischeggia)
Glass doors mirror (with shatterproof safety film)

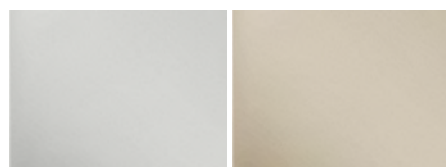

argentato
silver

bronzato
bronzed

Profili e Maniglie
Profiles and Handles

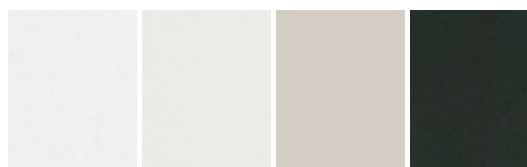

bianco talco
talc white

pumice
pumice

cashmere
cashmere

brunito
burnished

vetro lucido e opaco temprato matt and glossy toughened glass



bianco talco
talc white

pumice
pumice

cashmere

arena

selce
flint

agave

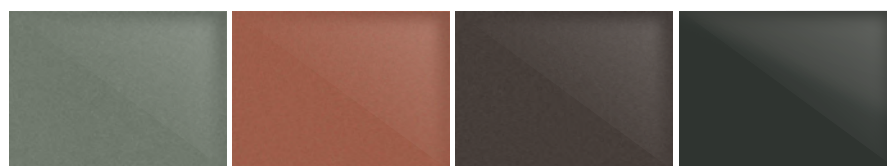

ottanio
octane

terracotta

lava

brunito
burnished

Ante City Glass City Glass doors
vetri temprati cat. T1 Toughened glass cat. T1

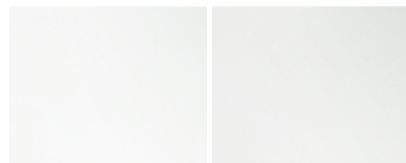

trasparente
transparent

trasparente fumè
transparent smoked grey

vetri temprati cat.T2 Toughened glass cat. T2



riflettente chiaro
light reflective

cannettato trasparente
fluted transparent

Per effetto del procedimento di fabbricazione il vetro cannettato può presentare piccole inclusioni e/o micro bollicine che non sono da considerarsi difetti ma peculiarità del prodotto.

As a result of the manufacturing have small inclusions and/or micro bubbles, which are not to be considered defects but peculiarities of the product.

Telai Frames

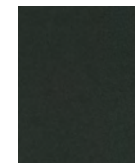

brunito
burnished

New finishes Agave, Terracotta and Lava are available for:

- all the melamine elements,, except BENT bed
- end sides of the wardrobes with Seame internal finish
- glossy and mat glasses (GLASS hinged doors, MIXER GLASS, DOUBLE GLASS sliding doors, glass top for GRIP and TREND complements)
- GRIP, GOLA, MIXER, DOUBLE, DOUBLE GLASS profiles, BREAK, CIAK embedded handles with the same price increase of the colors in price range 2
- type R, type F, BENCH, SHANGHAI, type M, RULER, VIRGOLA handles (from page 12 to page 25)
- TOPPER, RAKED, RULER bed's legs, 10x2 desk's legs with the same price increase of the colors in price range 2
- metal hanging accessorizes with the same price increase of the colors in price range 2 (from page 495 to page 501 and page 561)

I nuovi colori Agave, Terracotta e Lava sono disponibili per:

- tutti gli elementi in melaminico ad esclusione del letto BENT
- tutti i fianchi terminali armadio con finitura interna Sesamo
- vetri lucidi e opachi (ante battenti GLASS, ante scorrevoli MIXER GLASS, DOUBLE GLASS, top in vetro per complementi GRIP e TREND)
- maniglie a profilo GRIP, GOLA, MIXER, DOUBLE, DOUBLE GLASS, maniglie a incasso BREAK, CIAK, con le medesime maggiorazioni previste per i colori di fascia 2
- maniglie tipo R, tipo F, BENCH, SHANGHAI, tipo M, RULER, VIRGOLA (da pag. 12 a pag. 24)
- gambe per letti TOPPER, RAKED, RULER, gambe scrittoio 10X2, con le medesime maggiorazioni previste per i colori di fascia 2
- accessori da aggancio in metallo con le medesime maggiorazioni previste per i colori di fascia 2 (da pag. 495 a pag. 501 e pag. 561)

ARMADI ANTE COMPLANARI – ALTERNA

WARDROBES WITH COPLANAR DOORS – ALTERNA



ALTEZZE HEIGHTS

comprensiva di piedino regolabile da 0.6 a 2.5 cm adjustable foot from 0.6 to 2.5 cm included

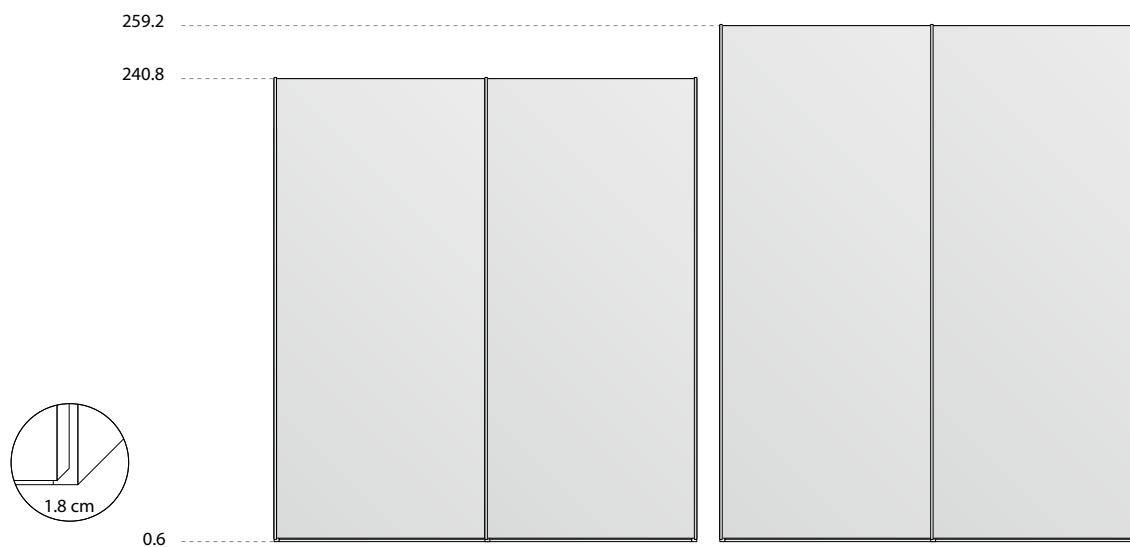

Altezze fianchi escluse di piedino 240.2 – 258.6 cm Heights of sides without foot 240.2 – 258.6 cm

LARGHEZZE WIDTHS

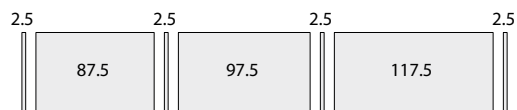

PROFONDITÀ DEPTHS

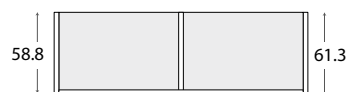

Terminale con appendino
End unit with hanging rail

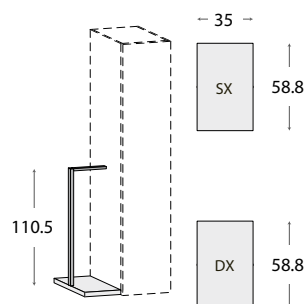

ANTA COMPLANARE PLANA
PLANA COPLANAR DOOR

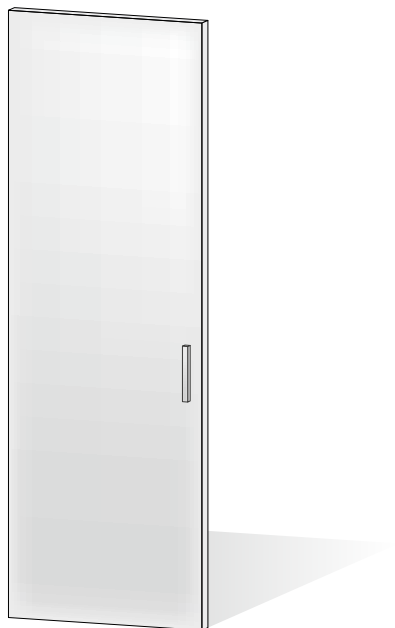

CARATTERISTICHE TECNICHE

- L'anta complanare Plana è composta da:
- pannello melaminico in agglomerato di legno Sp. 2.2 cm
 - compresa maniglia senza maggiorazione
 - dotata di dispositivo raddrizza-anta
 - con sistema di scorrimento ammortizzato di serie in apertura e chiusura

TECHNICAL CHARACTERISTICS

- Plana coplanar door composed of:
- wood agglomerate melamine panel Th. 2.2 cm
 - with handle with surcharge
 - fitted with straighten-door device.
 - with standard soft-close sliding system

N.B.: Attrezzabile con maniglia RULER nei colori:

bianco talco – pomice – cashmere – olmo ash – arena – selce – ottanio – ardesia – rovere natural – noce – lignum dark

N.B.: Can be fitted with RULER handle in the following colours:

talc white - pumice - cashmere - ash elm - arena - flint - octane - slate - natural oak - walnut - lignum dark

Attrezzabile con maniglia PLAN nei colori: Bianco talco – 0 chimico – Brunito

Can be fitted with PLAN handle in the following colours: Talc white – 0 finish – Burnished

ANTA COMPLANARE BREAK verticale

Vertical BREAK COPLANAR DOOR



FRONTALI

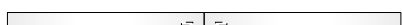
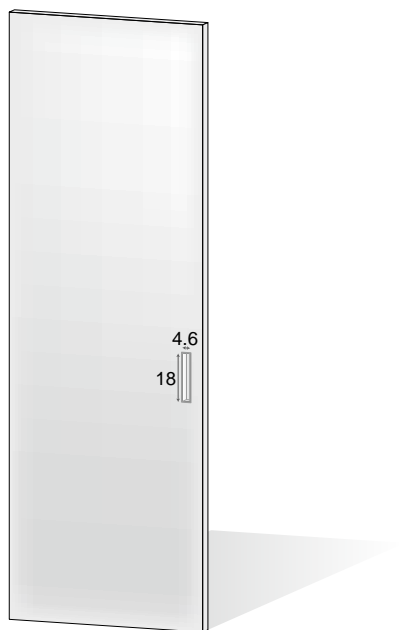

CARATTERISTICHE TECNICHE

L'anta complanare Break è composta da:

– pannello melaminico in agglomerato di legno Sp. 2.2 cm

Finitura maniglia Break

bianco talco - pomice - cashmere

arena -selce -ottanio - agave - terracotta- opus calce - opus cemento - opus mattone - brunito - lava

– dotata di dispositivo raddrizza-anta

– con sistema di scorrimento ammortizzato di serie in apertura e chiusura

TECHNICAL CHARACTERISTICS

Break coplanar door composed of:

– wood agglomerate melamine panel Th. 2.2 cm

Break handle finish

talco white - pumice - cashmere

- arena - flint - octane - agave - terracotta - opus lime - opus concrete - opus brick - burnished - lava

– fitted with straighten-door device.

– with standard soft-close sliding system