

ALTERNA BATTENTE E A LIBRO

ALTERNA WARDROBE WITH HINGED AND BIFOLD DOOR



scheda tecnica data sheet

ESTERNO / FRONTALI - FINITURE COLORI

EXTERNAL FINISHES / FRONTS - FINISHES AND COLOURS

Fascia 1 finitura liscia Price range 1 plain finish

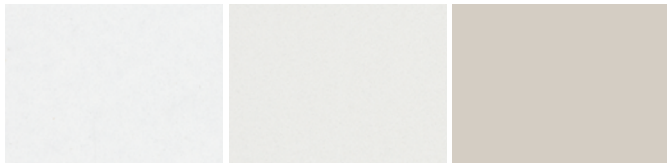

bianco talco
talc white

pomice
pumice

cashmere
cashmere

Fascia 2 finitura liscia Price range 2 plain finish



arena
arena

selce
flint

agave

ottanio
octane

terracotta

lava

finitura materica textured finish

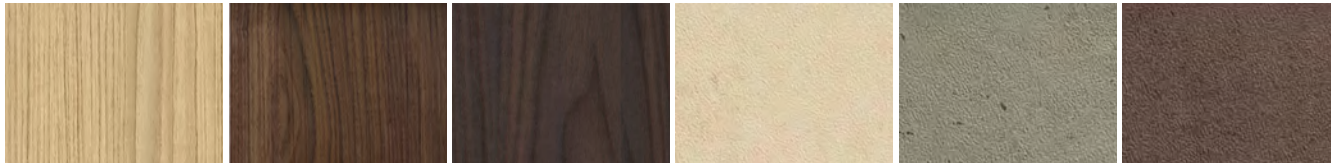

rovere natural
natural oak

noce
walnut

lignum dark

opus calce
opus lime

opus cemento
opus concrete

opus mattone
opus brick

Fascia 2 Solo frontali (esclusi cassetti esterni) e pannelli schienale cabina Flexy

Price range 2 Only fronts (external drawers not included) and back panels for Flexy walk-in closet

finitura materica textured finish



cretto cashmere

cocò

INTERNO / SCOCCA E ATTREZZATURA INTERNA ARMADI ALTERNA
INTERNAL FINISHES / CARCASE AND INTERIOR FITTING FOR ALTERNA WARDROBES

finitura materica textured finish

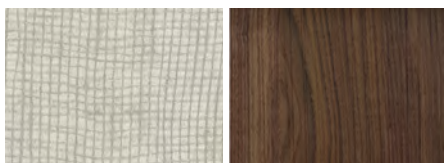

sesamo
sesame

noce
walnut

FIANCHI TERMINALI Sp. 2.5 cm END SIDE PANELS Th. 2.5 cm

Parte interna
Internal part

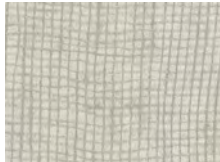

sesamo
sesame

Parte esterna
External part

FASCIA 1
PRICE RANGE 1



bianco talco
talc white

pomice
pumice

cashmere

FASCIA 2
PRICE RANGE 2



arena

selce
flint

agave

ottanio
octane

terracotta

lava

rovere natural
natural oak

lignum dark

opus calce
opus lime

opus cemento
opus concrete

opus mattone
opus brick

Parte interna
Internal part

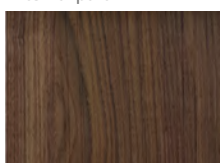

noce
walnut

Parte esterna
External part

FASCIA 1
PRICE RANGE 1

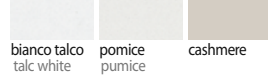

bianco talco
talc white

pomice
pumice

cashmere

FASCIA 2
PRICE RANGE 2



noce
walnut

ANTE A VETRO GLASS DOORS

Ante Glass specchio (dotato di pellicola di sicurezza antischeggia)
Glass doors mirror (with shatterproof safety film)

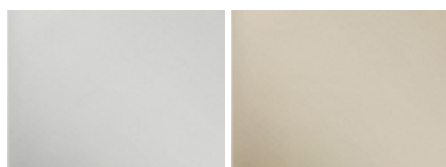

argentato
silver

bronzato
bronzed

Profili e Maniglie
Profiles and Handles

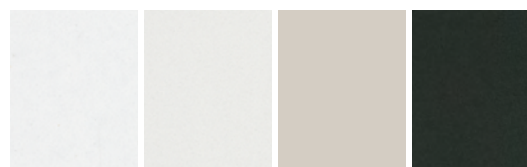

bianco talco
talc white

pomice
pumice

cashmere
cashmere

brunito
burnished

vetro lucido e opaco temprato matt and glossy toughened glass



bianco talco
talc white

pomice
pumice

cashmere

arena

selce
flint

agave

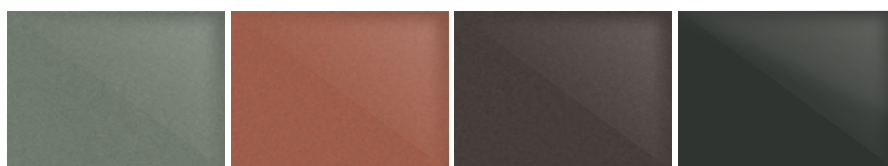

ottanio
octane

terracotta

lava

brunito
burnished

Ante City Glass City Glass doors
vetri temprati cat. T1 Toughened glass cat. T1

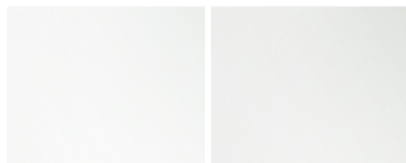

trasparente
transparent

trasparente fumè
transparent smoked grey

vetri temprati cat. T2 Toughened glass cat. T2



riflettente chiaro
light reflective

cannettato trasparente
fluted transparent

Per effetto del procedimento di fabbricazione il vetro cannettato può presentare piccole inclusioni e/o micro bollicine che non sono da considerarsi difetti ma peculiarità del prodotto.

As a result of the manufacturing have small inclusions and/or micro bubbles, which are not to be considered defects but peculiarities of the product.

Telai Frames

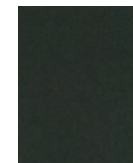

brunito
burnished

New finishes Agave, Terracotta and Lava are available for:

- all the melamine elements,, except BENT bed
- end sides of the wardrobes with Seame internal finish
- glossy and mat glasses (GLASS hinged doors, MIXER GLASS, DOUBLE GLASS sliding doors, glass top for GRIP and TREND complements)
- GRIP, GOLLA, MIXER, DOUBLE, DOUBLE GLASS profiles, BREAK, CIAK embedded handles with the same price increase of the colors in price range 2
- type R, type F, BENCH, SHANGHAI, type M, RULER, VIRGOLA handles (from page 12 to page 25)
- TOPPER, RAKED, RULER bed's legs, 10x2 desk's legs with the same price increase of the colors in price range 2
- metal hanging accessorizes with the same price increase of the colors in price range 2 (from page 495 to page 501 and page 561)

I nuovi colori Agave, Terracotta e Lava sono disponibili per:

- tutti gli elementi in melaminico ad esclusione del letto BENT
- tutti i fianchi terminali armadio con finitura interna Sesamo
- vetri lucidi e opachi (ante battenti GLASS, ante scorrevoli MIXER GLASS, DOUBLE GLASS, top in vetro per complementi GRIP e TREND)
- maniglie a profilo GRIP, GOLLA, MIXER, DOUBLE, DOUBLE GLASS, maniglie a incasso BREAK, CIAK, con le medesime maggiorazioni previste per i colori di fascia 2
- maniglie tipo R, tipo F, BENCH, SHANGHAI, tipo M, RULER, VIRGOLA (da pag. 12 a pag. 24)
- gambe per letti TOPPER, RAKED, RULER, gambe scrittoio 10X2, con le medesime maggiorazioni previste per i colori di fascia 2
- accessori da aggancio in metallo con le medesime maggiorazioni previste per i colori di fascia 2 (da pag. 495 a pag. 501 e pag. 561)

ANTA BATTENTE PLANA
HINGED DOOR PLANA



CARATTERISTICHE TECNICHE

L'anta battente Plana è composta da:

- pannello melaminico in agglomerato di legno Sp. 2.2 cm
- maniglia senza maggiorazione, oppure push-pull ordinando a parte il ripiano dedicato, vedi attrezzatura interna

TECHNICAL CHARACTERISTICS

Plana hinged door composed of:

- wood agglomerate melamine panel Th. 2.2 cm
- handle without surcharge, or push-pull by ordering the shelf separately, see interior fitting

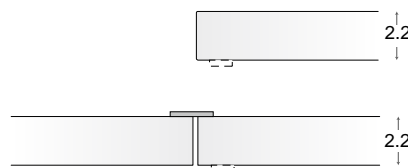

ALTEZZE HEIGHTS

comprensiva di piedino regolabile da 0.6 a 2.5 cm adjustable foot 0.6 cm included

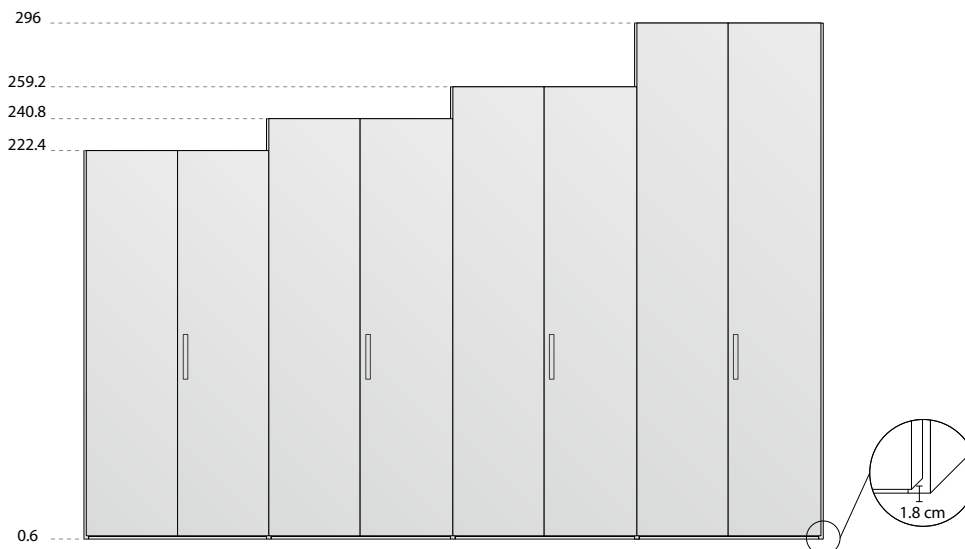

Altezze fianchi escluse di piedino 221.8 - 240.2 - 258.6 - 295.4 cm
Heights of sides without foot 221.8 - 240.2 - 258.6 - 295.4 cm

LARGHEZZE WIDTHS

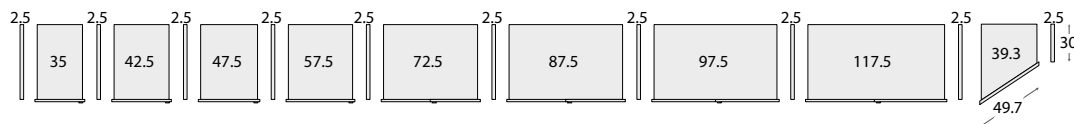

PROFONDITA' DEPTHS

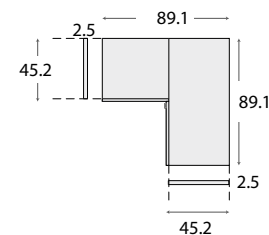
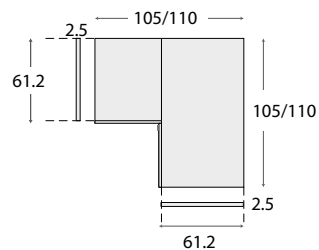
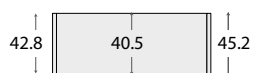
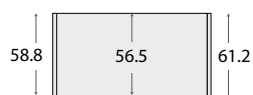

CARATTERISTICHE TECNICHE

L'anta battente Plana è composta da:

- pannello melaminico in agglomerato di legno Sp. 2.2 cm
- maniglia senza maggiorazione, oppure push-pull ordinando a parte il ripiano dedicato, vedi attrezzatura interna

TECHNICAL CHARACTERISTICS

Plana hinged door composed of:

- wood agglomerate melamine panel Th. 2.2 cm
- handle without surcharge, or push-pull by ordering the shelf separately, see interior fitting



ALTEZZE HEIGHTS

comprensiva di piedino regolabile da 0.6 a 2.5 cm adjustable foot 0.6 cm included

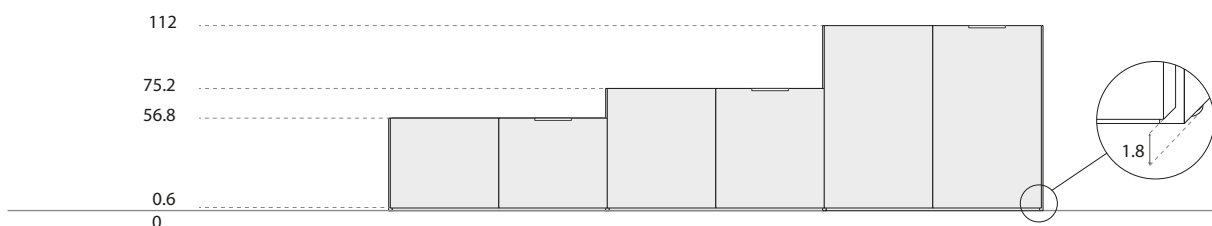

LARGHEZZE WIDTHS

* N.B.: Modulo non disponibile per cassettoni H. 36.4 cm Not available for drawers H. 36.4 cm

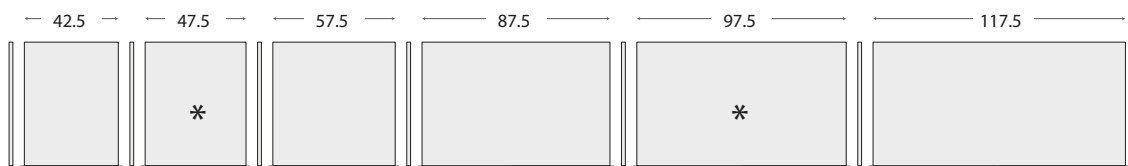

PROFONDITÀ DEPTH

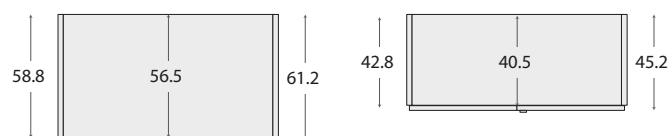



CARATTERISTICHE TECNICHE

L'anta battente Plana è composta da:

- pannello melaminico in agglomerato di legno Sp. 2.2 cm
- maniglia senza maggiorazione, oppure push-pull ordinando a parte il ripiano dedicato, vedi attrezzatura interna

TECHNICAL CHARACTERISTICS

Plana hinged door composed of:

- wood agglomerate melamine panel Th. 2.2 cm
- handle without surcharge, or push-pull by ordering the shelf separately, see interior fitting

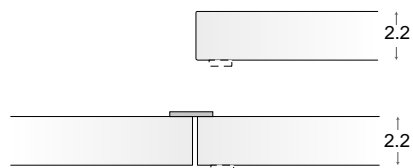

ALTEZZE HEIGHTS

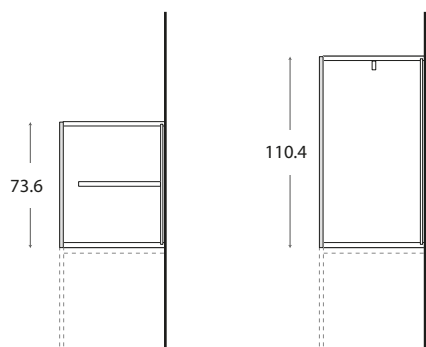

LARGHEZZE WIDTHS



PROFONDITÀ DEPTH

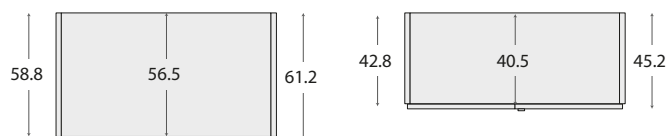

ANTA BATTENTE PLANA STAGIONALE E SOPRALZO
 PLANA STAGIONALE AND A SOPRALZO HINGED DOOR

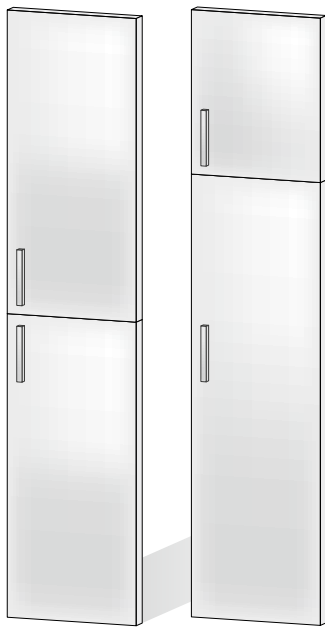

CARATTERISTICHE TECNICHE

L'anta battente Plana Stagionale è composta da:

- pannello melaminico in agglomerato di legno Sp. 2.2 cm
- maniglia senza maggiorazione, oppure push-pull ordinando a parte il ripiano dedicato, vedi attrezzatura interna

TECHNICAL CHARACTERISTICS

Plana Stagionale hinged door composed of:

- wood agglomerate melamine panel Th. 2.2 cm
- handle without surcharge, or push-pull by ordering the shelf separately, see interior fitting

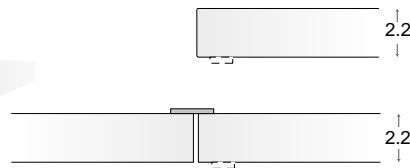

ALTEZZE HEIGHTS

comprensiva di piedino regolabile da 0.6 a 2.5 cm adjustable foot 0.6 cm included

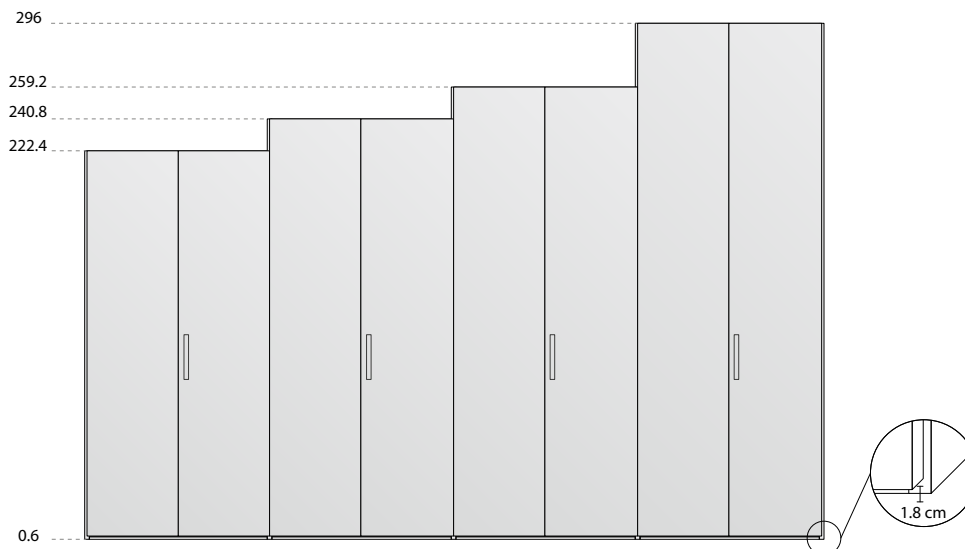

Altezze fianchi escluse di piedino 221.8 - 240.2 - 258.6 - 295.4 cm
 Heights of sides without foot 221.8 - 240.2 - 258.6 - 295.4 cm

LARGHEZZE WIDTHS

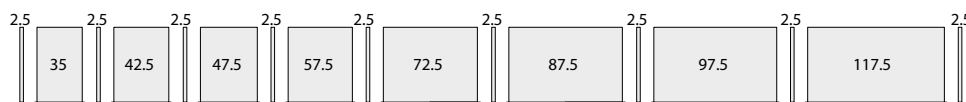

PROFONDITA' DEPTHS



ANTA BATTENTE GRIP
GRIP HINGED DOOR



CARATTERISTICHE TECNICHE

L'anta battente Grip è composta da:

- pannello melaminico in agglomerato di legno Sp. 2.2 cm
- Finitura profilo Grip

bianco talco - pomice - cashmere

arena -selce -ottanio - agave - terracotta- opus calce - opus cemento - opus mattone - brunito - lava

TECHNICAL CHARACTERISTICS

Grip hinged door composed of:

- wood agglomerate melamine panel Th. 2.2 cm
- Grip profile finish

talco white - pumice - cashmere

- arena - flint - octane - agave - terracotta - opus lime - opus concrete - opus brick - burnished - lava

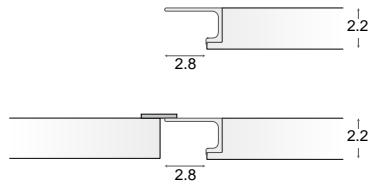

ALTEZZE HEIGHTS

comprensiva di piedino regolabile da 0.6 a 2.5 cm adjustable foot 0.6 cm included

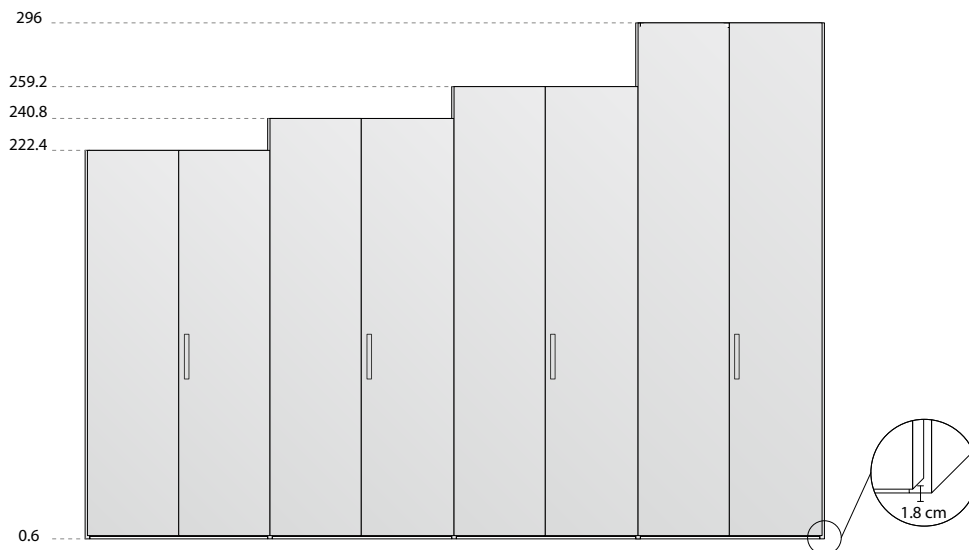

Altezze fianchi escluse di piedino 221.8 – 240.2 – 258.6 – 295.4 cm
Heights of sides without foot 221.8 – 240.2 – 258.6 – 295.4 cm

LARGHEZZE WIDTHS

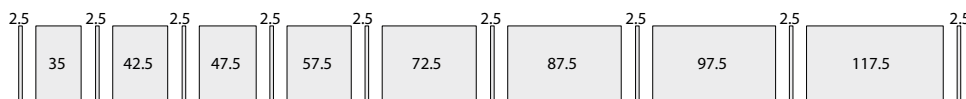

PROFONDITA' DEPTHS



ANTA BATTENTE GOLA

GOLA HINGED DOOR



CARATTERISTICHE TECNICHE

L'anta battente Gola è composta da:

- pannello melaminico in agglomerato di legno Sp. 2.2 cm
- Finitura profilo Gola per anta
bianco talco - pomice - cashmere
arena -selce -ottanio - agave - terracotta- opus calce - opus cemento - opus mattone - brunito - lava
- Finitura profilo Grip per cassetto
bianco talco - pomice - cashmere
arena -selce -ottanio - agave - terracotta- opus calce - opus cemento - opus mattone - brunito - lava

TECHNICAL CHARACTERISTICS

Gola hinged door composed of:

- wood agglomerate melamine panel Th. 2.2 cm
- Gola profile finish for door
talc white - pumice - cashmere
- arena - flint - octane - agave - terracotta - opus lime - opus concrete - opus brick - burnished - lava
- Gola profile finish for drawer
talc white - pumice - cashmere
- arena - flint - octane - agave - terracotta - opus lime - opus concrete - opus brick - burnished - lava

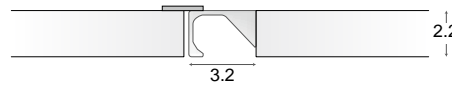
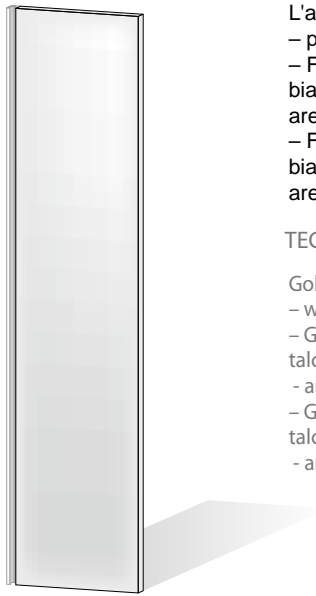

ALTEZZE HEIGHTS

comprensiva di piedino regolabile da 0.6 a 2.5 cm adjustable foot 0.6 cm included

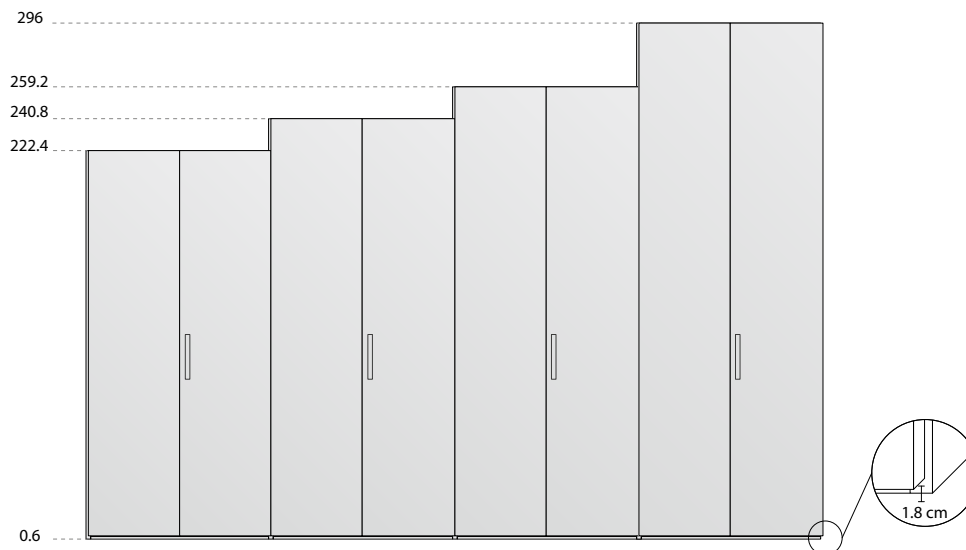

Altezze fianchi escluse di piedino 221.8 – 240.2 – 258.6 – 295.4 cm
Heights of sides without foot 221.8 – 240.2 – 258.6 – 295.4 cm

LARGHEZZE WIDTHS

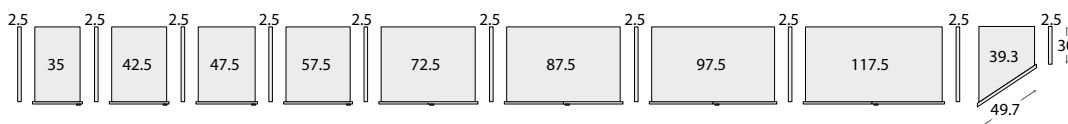

PROFONDITA' DEPTHS

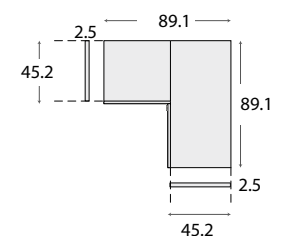
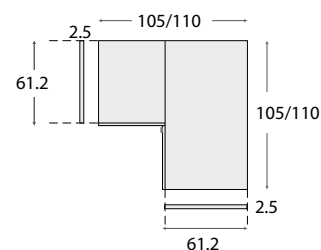
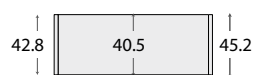
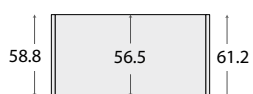

CARATTERISTICHE TECNICHE

L'anta battente Gola è composta da:

- pannello melaminico in agglomerato di legno Sp. 2.2 cm
- Finitura profilo per anta
 bianco talco - pomice - cashmere
 arena -selce -ottanio - agave - terracotta- opus calce - opus cemento - opus mattone - brunito - lava
- Finitura profilo per cassetto
 bianco talco - pomice - cashmere
 arena -selce -ottanio - agave - terracotta- opus calce - opus cemento - opus mattone - brunito - lava

TECHNICAL CHARACTERISTICS

Gola hinged door composed of:

- wood agglomerate melamine panel Th. 2.2 cm
- Profile finish for door
 talc white - pumice - cashmere
 arena - flint - octane - agave - terracotta - opus lime - opus concrete - opus brick - burnished - lava
- Profile finish for drawer
 talc white - pumice - cashmere
 arena - flint - octane - agave - terracotta - opus lime - opus concrete - opus brick - burnished - lava

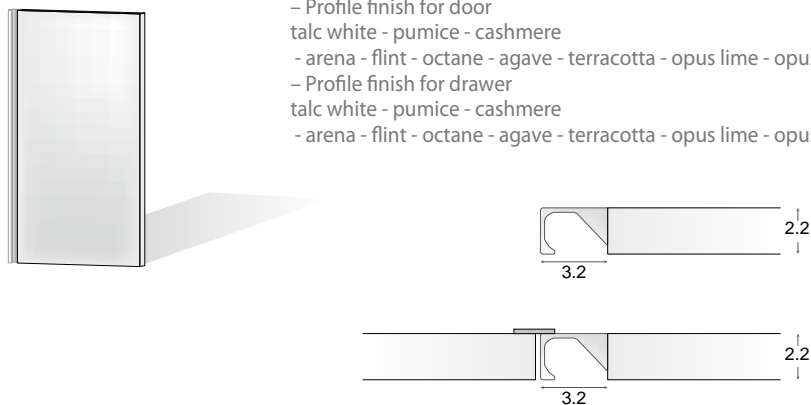

ALTEZZE HEIGHTS

comprensiva di piedino regolabile da 0.6 a 2.5 cm adjustable foot 0.6 cm included

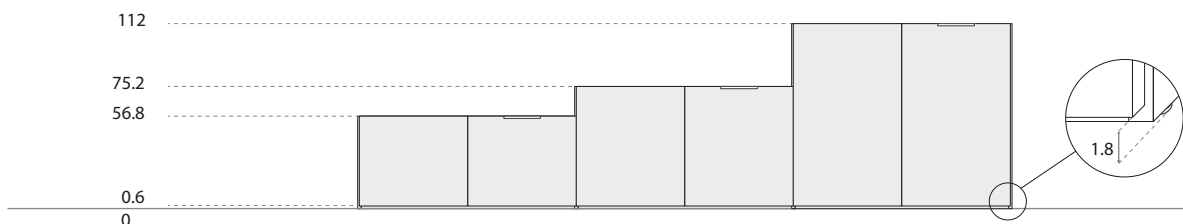

LARGHEZZE WIDTHS

* N.B.: Modulo non disponibile per cassettoni H. 36.4 cm Not available for drawers H. 36.4 cm

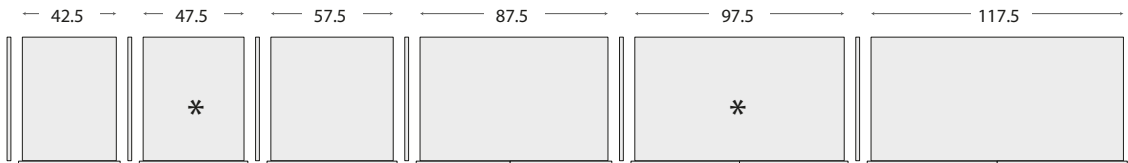

PROFONDITÀ DEPTH

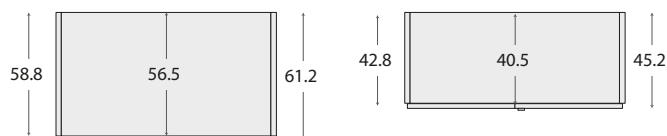

CARATTERISTICHE TECNICHE

L'anta battente Gola è composta da:

- pannello melaminico in agglomerato di legno Sp. 2.2 cm
- Finitura profilo per anta
 bianco talco - pomice - cashmere
 arena -selce -ottanio - agave - terracotta- opus calce - opus cemento - opus mattone - brunito - lava
- Finitura profilo per cassetto
 bianco talco - pomice - cashmere
 arena -selce -ottanio - agave - terracotta- opus calce - opus cemento - opus mattone - brunito - lava

TECHNICAL CHARACTERISTICS

Gola hinged door composed of:

- wood agglomerate melamine panel Th. 2.2 cm
- profile finish for door
 talc white - pumice - cashmere
 - arena - flint - octane - agave - terracotta - opus lime - opus concrete - opus brick - burnished - lava
- profile finish for drawer
 talc white - pumice - cashmere
 - arena - flint - octane - agave - terracotta - opus lime - opus concrete - opus brick - burnished - lava

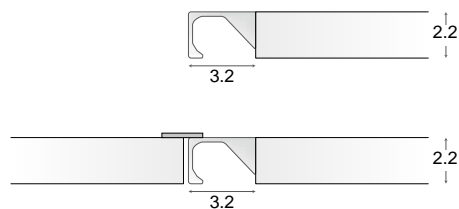

ALTEZZE HEIGHTS

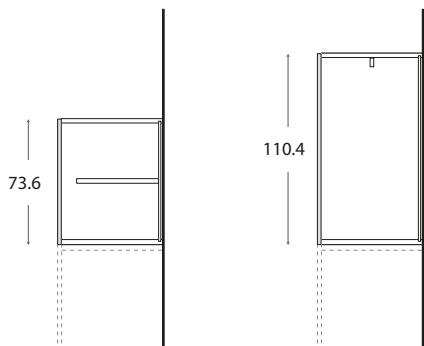

LARGHEZZE WIDTHS



PROFONDITÀ DEPTH

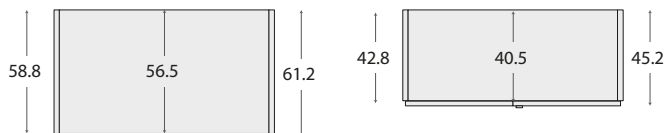

ANTA BATTENTE MIXER
MIXER HINGED DOOR



CARATTERISTICHE TECNICHE

L'anta battente Mixer è composta da:
 - pannello melaminico in agglomerato di legno Sp. 2.2 cm
 - Finitura profilo Mixer
 bianco talco - pomice - cashmere
 arena - selce - ottanio - agave - terracotta- opus calce - opus cemento - opus mattone - brunito - lava

TECHNICAL CHARACTERISTICS

Mixer hinged door composed of:
 - wood agglomerate melamine panel Th. 2.2 cm
 - Mixer profile finish
 talc white - pumice - cashmere
 - arena - flint - octane - agave - terracotta - opus lime - opus concrete - opus brick - burnished - lava

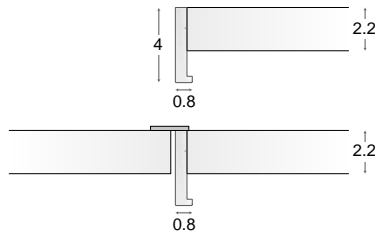

ALTEZZE HEIGHTS

comprensiva di piedino regolabile da 0.6 a 2.5 cm adjustable foot 0.6 cm included

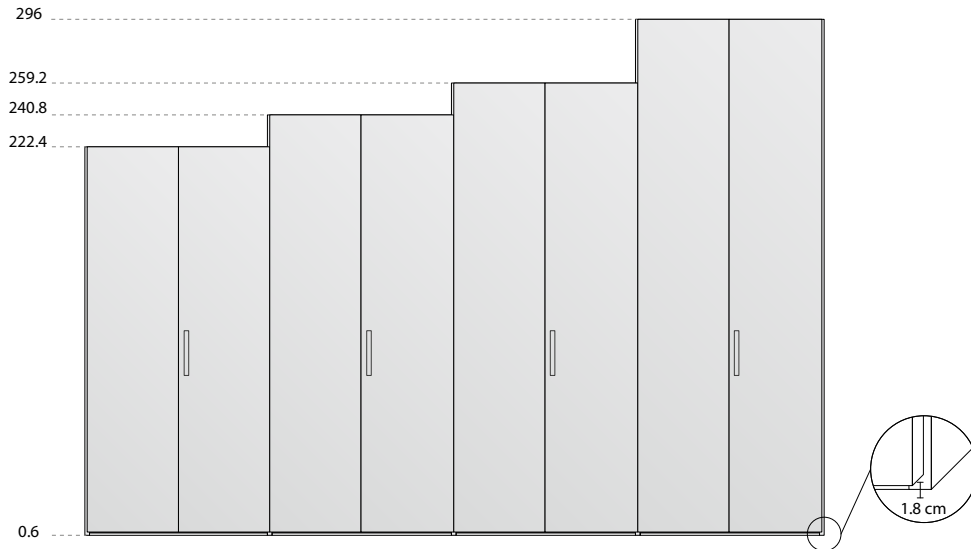

Altezze fianchi escluse di piedino 221.8 - 240.2 - 258.6 - 295.4 cm
 Heights of sides without foot 221.8 - 240.2 - 258.6 - 295.4 cm

LARGHEZZE WIDTHS

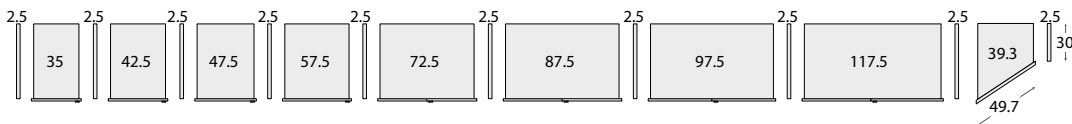

PROFONDITA' DEPTHS



ANTA BATTENTE CITY
CITY HINGED DOOR



CARATTERISTICHE TECNICHE

L'anta battente City è composta da:
 - coppia profili verticali SX/DX in alluminio con maniglia integrata
 con cerniere portanti e pannello melaminico in agglomerato di legno Sp. 1.8 cm
 - Finitura profilo City
 bianco talco - pomice - cashmere - brunito

TECHNICAL CHARACTERISTICS

City hinged door composed of:
 - pair of LH/RH aluminium vertical profiles with integrated handle,
 supporting hinges and wood agglomerate melamine panel Th. 1.8 cm
 - City profile finish
 talc white - pumice - cashmere - burnished

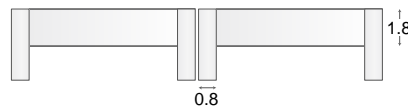
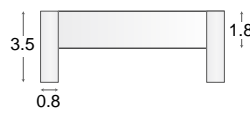
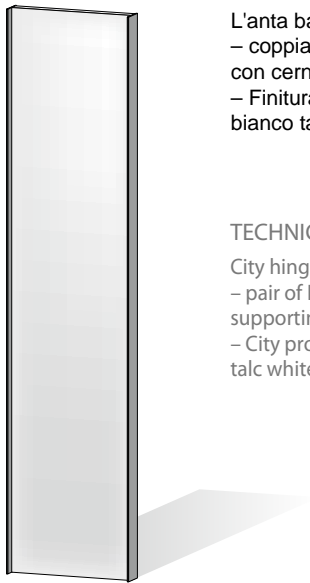

ALTEZZE HEIGHTS

comprensiva di piedino regolabile da 0.6 a 2.5 cm adjustable foot 0.6 cm included

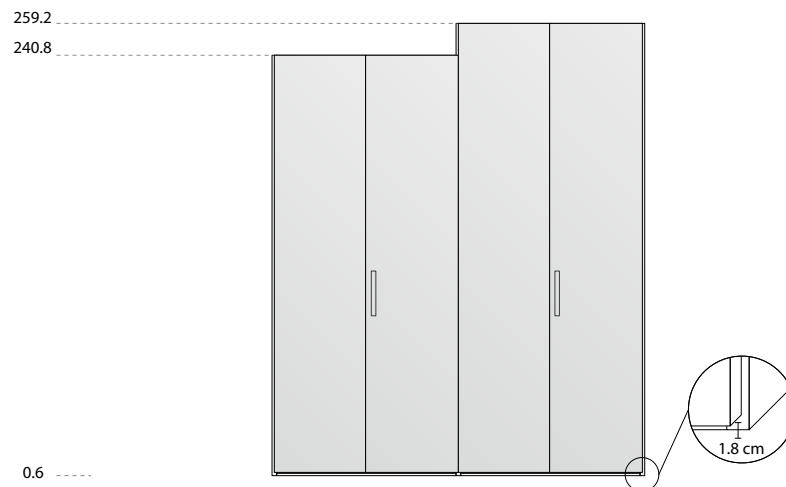

Altezze fianchi escluse di piedino 221.8 - 240.2 - 258.6
 Heights of sides without foot 221.8 - 240.2 - 258.6

LARGHEZZE WIDTHS

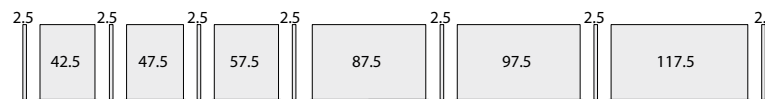

PROFONDITA' DEPTHS



ANTA BATTENTE BREAK orizzontale – verticale
horizontal – vertical BREAK HINGED DOOR



CARATTERISTICHE TECNICHE

L'anta battente Break è composta da:

- pannello melaminico in agglomerato di legno Sp. 2.2 cm
- Finitura maniglia Break

bianco talco - pomice - cashmere

arena -selce -ottanio - agave - terracotta- opus calce - opus cemento - opus mattone - brunito - lava

TECHNICAL CHARACTERISTICS

Break hinged door composed of:

- wood agglomerate melamine panel Th. 2.2 cm
- Break handle finish

talco white - pumice - cashmere

- arena - flint - octane - agave - terracotta - opus lime - opus concrete - opus brick - burnished - lava

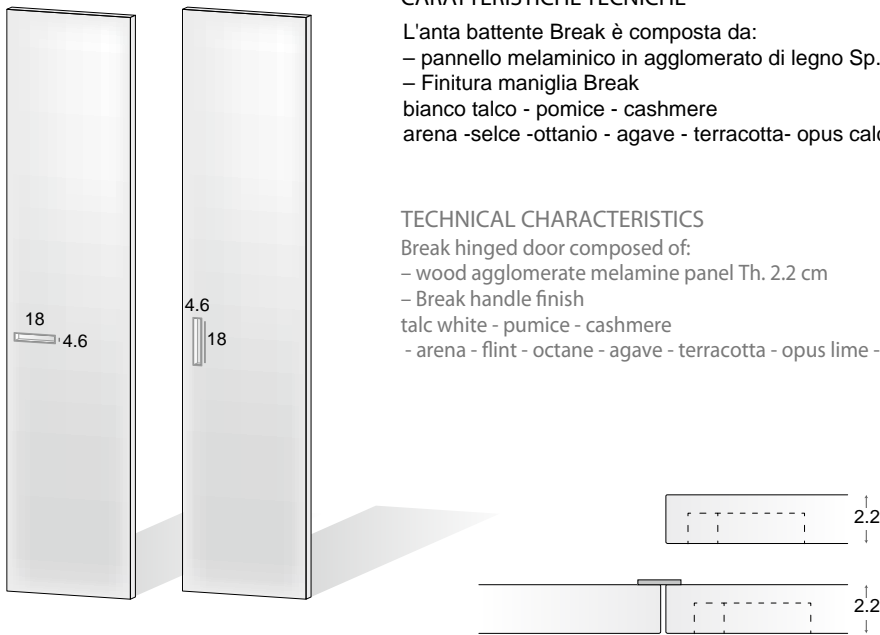

ALTEZZE HEIGHTS

comprensiva di piedino regolabile da 0.6 a 2.5 cm adjustable foot 0.6 cm included

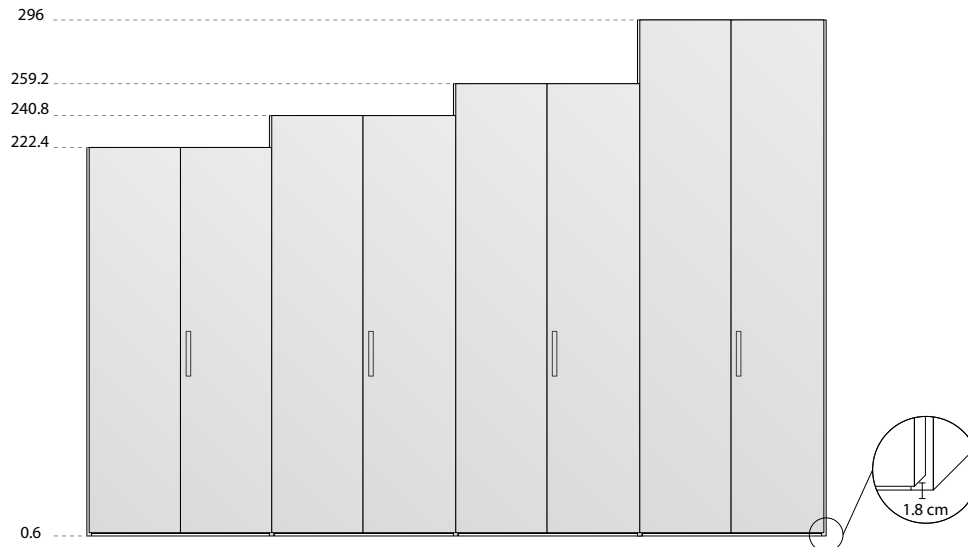

Altezze fianchi escluse di piedino 221.8 – 240.2 – 258.6 – 295.4 cm
Heights of sides without foot 221.8 – 240.2 – 258.6 – 295.4 cm

LARGHEZZE WIDTHS

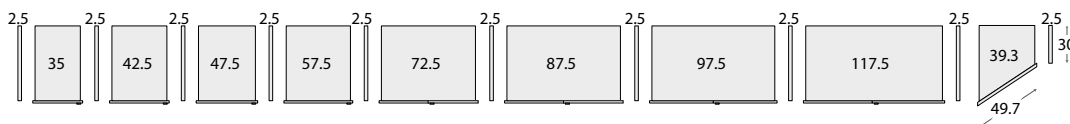

PROFONDITA' DEPTHS



ANTA BATTENTE CIAK corta-lunga

short – long CIAK HINGED DOOR



CARATTERISTICHE TECNICHE

L'anta battente Ciak è composta da:

- pannello melaminico in agglomerato di legno Sp. 2.2 cm

- Finitura maniglia Break

bianco talco - pomice - cashmere

arena -selce -ottanio - agave - terracotta- opus calce - opus cemento - opus mattone - brunito - lava

TECHNICAL CHARACTERISTICS

Ciak hinged door composed of:

- wood agglomerate melamine panel Th. 2.2 cm

- Ciak handle finish

talc white - pumice - cashmere

- arena - flint - octane - agave - terracotta - opus lime - opus concrete - opus brick - burnished - lava

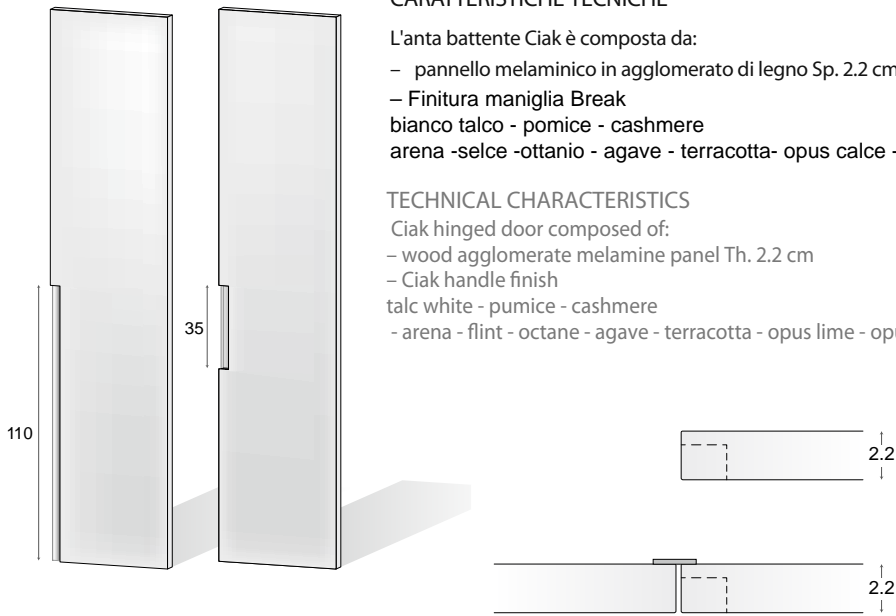

ALTEZZE HEIGHTS

comprensiva di piedino regolabile da 0.6 a 2.5 cm adjustable foot 0.6 cm included

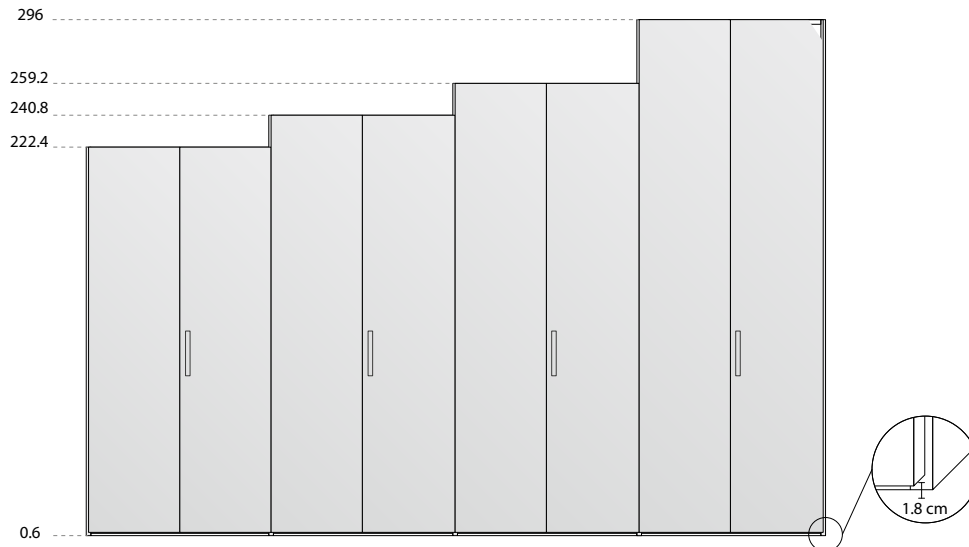

Altezze fianchi escluse di piedino 221.8 – 240.2 – 258.6 – 295.4 cm

Heights of sides without foot 221.8 – 240.2 – 258.6 – 295.4 cm

LARGHEZZE WIDTHS

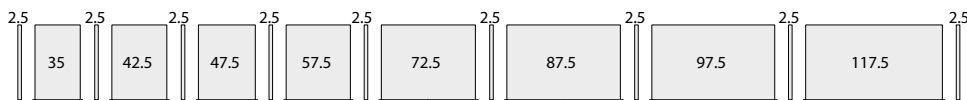

PROFONDITA' DEPTHS



ANTA BATTENTE GLASS

GLASS HINGED DOOR



CARATTERISTICHE TECNICHE

L'anta battente Glass è composta da:

- pannello melaminico in agglomerato di legno Sp. 1.8 cm e vetro 0.4 cm, con profili verticali e orizzontali in alluminio con finitura interna SESAMO – NOCE
- Finitura maniglia integrata su profilo: bianco talco – pomice – cashmere – Brunito

Finitura vetro:

- Specchio argentato o bronzato
- Vetro laccato lucido o opaco

TECHNICAL CHARACTERISTICS

Glass hinged door composed of:

- wood agglomerate melamine panel Th. 1.8 cm and glass 0.4 cm with vertical and horizontal aluminium profiles with internal finish in SESAME – WALNUT
- Handle integrated in the profile in the following finish: talc white – pumice – cashmere – Burnished

Glass finish:

- Bronzed and silver mirror
- Matt or glossy lacquered glass

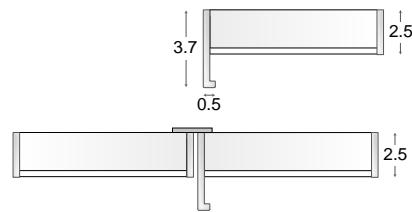
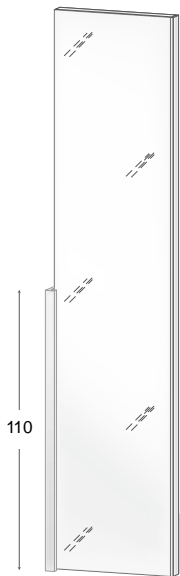

ALTEZZE HEIGHTS

comprensiva di piedino regolabile da 0.6 a 2.5 cm adjustable foot 0.6 cm included

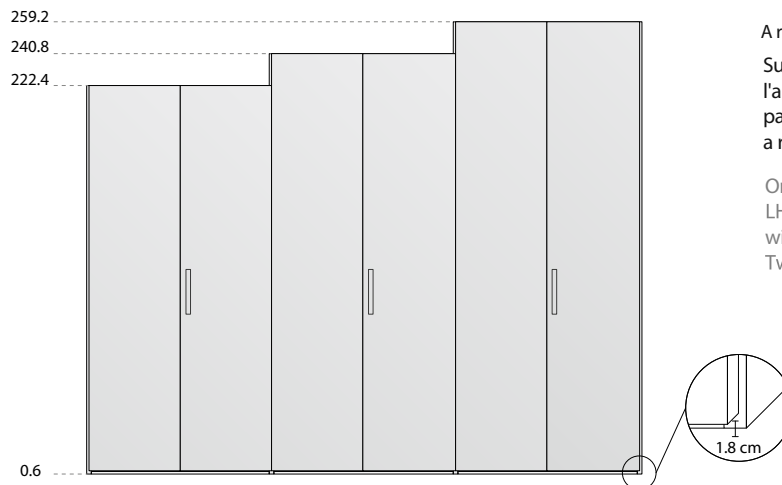

A richiesta si possono avere 2 ante uguali con profilo Glass

Sui moduli L. 87.5 – L. 97.5 – L. 117.5 di serie:

l'anta SX prevede la battuta parapolvere e l'anta DX la maniglia, a richiesta anche al contrario.

On modules W. 87.5 – W. 97.5 – W. 117.5 as standard: LH door is supplied with dust-proof profile and RH door with handle, upon request also opposite

Two identical doors with Glass profile can be provided on demand.

Altezze fianchi escluse di piedino 221.8 – 240.2 – 258.6

Heights of sides without foot 221.8 – 240.2 – 258.6

LARGHEZZE WIDTHS

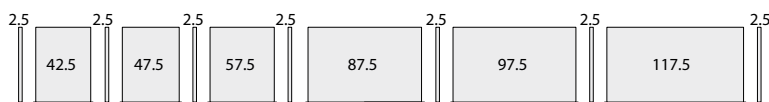

PROFONDITA' DEPTHS



ANTA BATTENTE CITY GLASS

CITY GLASS HINGED DOOR



CARATTERISTICHE TECNICHE

L'anta battente City Glass è composta da:
 - telaio alluminio con maniglia integrata con 2 cerniere portanti in finitura: brunito.
 - di serie chiusura rallentata.

TECHNICAL CHARACTERISTICS

City Glass hinged door composed of:
 - aluminium frame with integrated handle with 2 load-bearing hinges in burnished finish.
 - standard soft-close mechanism

L'anta a libro City Glass è composta da:
 - telaio alluminio con maniglia integrata con 3 cerniere portanti in finitura: brunito.
 - di serie chiusura rallentata.

City Glass bifold door composed of:
 - aluminium frame with integrated handle with 3 load-bearing hinges in burnished finish.
 - standard soft-close mechanism

Finitura: vetro temperato Sp. 0.4 cm:
 - trasparente - trasparente fumè (T1)
 - riflettente chiaro - cannettato trasparente (T2)

Finish: toughened glass Th. 0.4 cm:
 - transparent - transparent fumè (T1)
 - light reflective-fluted transparent (T2)

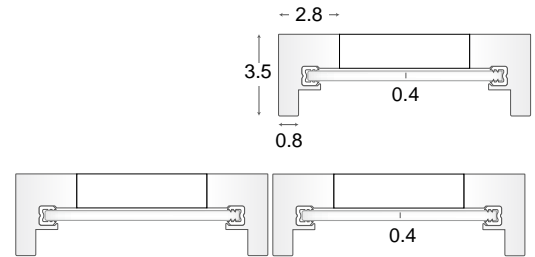

ALTEZZE HEIGHTS

comprensiva di piedino regolabile da 0.6 a 2.5 cm adjustable foot 0.6 cm included

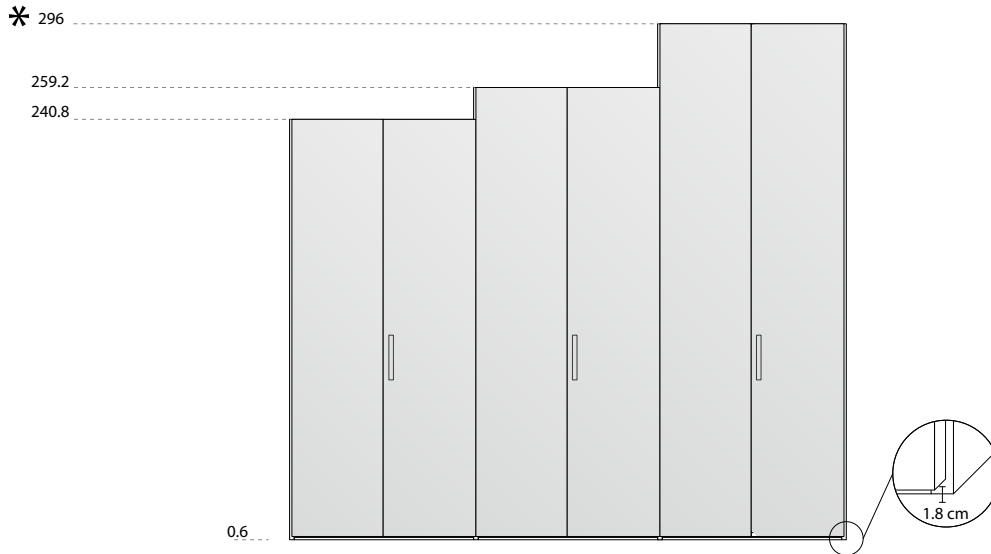

Altezze fianchi escluse di piedino 221.8 - 240.2 - 258.6
 Heights of sides without foot 221.8 - 240.2 - 258.6

LARGHEZZE WIDTHS

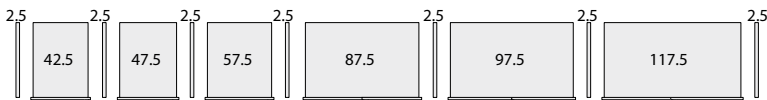

PROFONDITA' DEPTHS

