

ALTERNA SCORREVOLE  
WARDROBES WITH SLIDING DOORS – ALTERNA



scheda tecnica data sheet

ESTERNO / FRONTALI - FINITURE COLORI

EXTERNAL FINISHES / FRONTS - FINISHES AND COLOURS

Fascia 1 finitura liscia Price range 1 plain finish

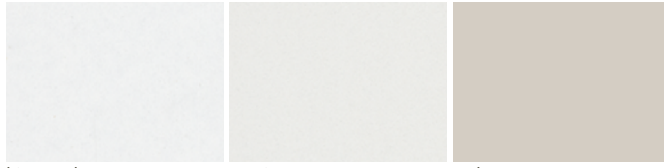

bianco talco  
talc white

pomice  
pumice

cashmere  
cashmere

Fascia 2 finitura liscia Price range 2 plain finish

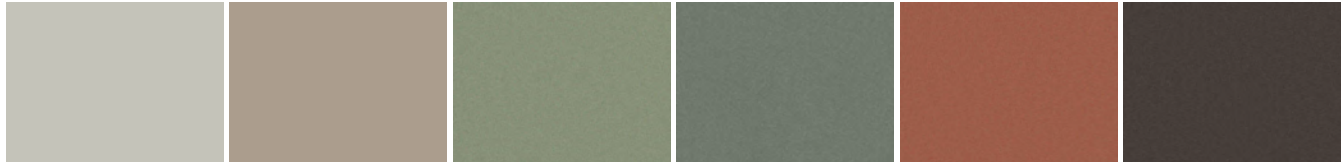

arena  
arena

selce  
flint

agave

ottanio  
octane

terracotta

lava

finitura materica textured finish

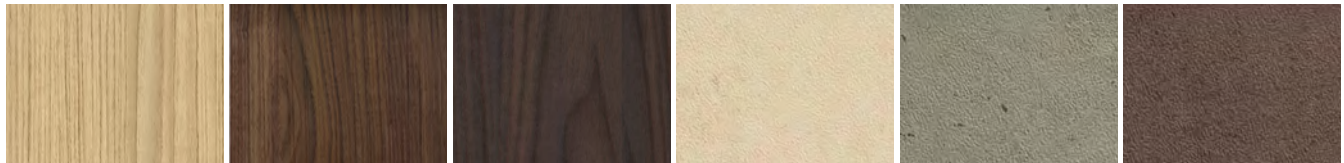

rovere natural  
natural oak

noce  
walnut

lignum dark

opus calce  
opus lime

opus cemento  
opus concrete

opus mattone  
opus brick

Fascia 2 Solo frontali (esclusi cassetti esterni) e pannelli schienale cabina Flexy

Price range 2 Only fronts (external drawers not included) and back panels for Flexy walk-in closet

finitura materica textured finish



cretto cashmere

cocò

INTERNO / SCOCCA E ATTREZZATURA INTERNA ARMADI ALTERNA  
INTERNAL FINISHES / CARCASE AND INTERIOR FITTING FOR ALTERNA WARDROBES

finitura materica textured finish

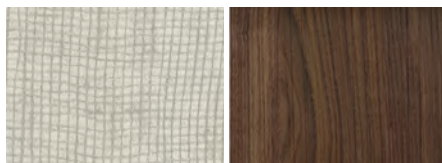

sesamo  
sesame

noce  
walnut

FIANCHI TERMINALI Sp. 2.5 cm END SIDE PANELS Th. 2.5 cm

Parte interna  
Internal part

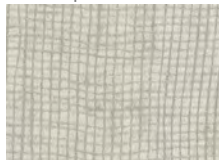

sesamo  
sesame

Parte esterna  
External part

FASCIA 1  
PRICE RANGE 1



bianco talco  
talc white

pomice  
pumice

cashmere

FASCIA 2  
PRICE RANGE 2



arena

selce  
flint

agave

ottanio  
octane

terracotta

lava

rovere natural  
natural oak

lignum dark

opus calce  
opus lime

opus cemento  
opus concrete

opus mattone  
opus brick

Parte interna  
Internal part

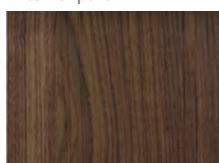

noce  
walnut

Parte esterna  
External part

FASCIA 1  
PRICE RANGE 1



bianco talco  
talc white

pomice  
pumice

cashmere

FASCIA 2  
PRICE RANGE 2



noce  
walnut

## ANTE A VETRO GLASS DOORS

**Ante Glass** specchio (dotato di pellicola di sicurezza antischeggia)  
Glass doors mirror (with shatterproof safety film)

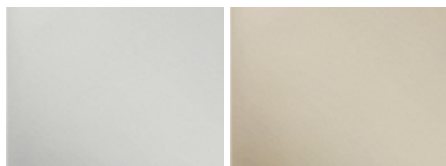

argento  
silver

bronzato  
bronzed

## Profili e Maniglie Profiles and Handles

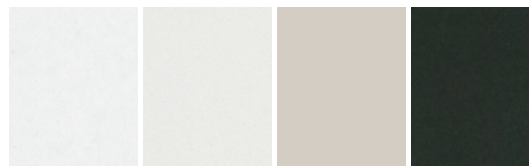

bianco talco  
talc white

pumice  
pumice

cashmere  
cashmere

brunito  
burnished

**vetro lucido e opaco temprato** matt and glossy toughened glass



bianco talco  
talc white

pumice  
pumice

cashmere

arena

selce  
flint

agave

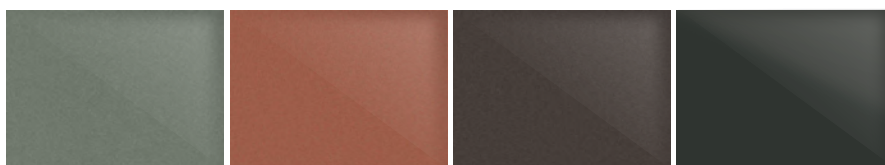

ottanio  
octane

terracotta

lava

brunito  
burnished

**Ante City Glass** City Glass doors  
vetri temprati cat. T1 Toughened glass cat. T1

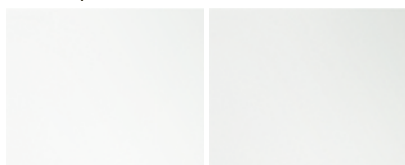

trasparente  
transparent

trasparente fumè  
transparent smoked grey

vetri temprati cat.T2 Toughened glass cat. T2



riflettente chiaro  
light reflective

cannettato trasparente  
fluted transparent

Per effetto del procedimento di fabbricazione il vetro cannettato può presentare piccole inclusioni e/o micro bollicine che non sono da considerarsi difetti ma peculiarità del prodotto.

As a result of the manufacturing have small inclusions and/or micro bubbles, which are not to be considered defects but peculiarities of the product.

**Telai** Frames

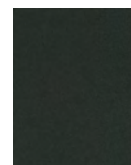

brunito  
burnished

New finishes Agave, Terracotta and Lava are available for:

- all the melamine elements,, except BENT bed
- end sides of the wardrobes with Seame internal finish
- glossy and mat glasses (GLASS hinged doors, MIXER GLASS, DOUBLE GLASS sliding doors, glass top for GRIP and TREND complements)
- GRIP, GOLA, MIXER, DOUBLE, DOUBLE GLASS profiles, BREAK, CIAK embedded handles with the same price increase of the colors in price range 2
- type R, type F, BENCH, SHANGHAI, type M, RULER, VIRGOLA handles (from page 12 to page 25)
- TOPPER, RAKED, RULER bed's legs, 10x2 desk's legs with the same price increase of the colors in price range 2
- metal hanging accessorizes with the same price increase of the colors in price range 2 (from page 495 to page 501 and page 561)

I nuovi colori Agave, Terracotta e Lava sono disponibili per:

- tutti gli elementi in melaminico ad esclusione del letto BENT
- tutti i fianchi terminali armadio con finitura interna Sesamo
- vetri lucidi e opachi (ante battenti GLASS, ante scorrevoli MIXER GLASS, DOUBLE GLASS, top in vetro per complementi GRIP e TREND)
- maniglie a profilo GRIP, GOLA, MIXER, DOUBLE, DOUBLE GLASS, maniglie a incasso BREAK, CIAK, con le medesime maggiorazioni previste per i colori di fascia 2
- maniglie tipo R, tipo F, BENCH, SHANGHAI, tipo M, RULER, VIRGOLA (da pag. 12 a pag. 24)
- gambe per letti TOPPER, RAKED, RULER, gambe scrittoio 10X2, con le medesime maggiorazioni previste per i colori di fascia 2
- accessori da aggancio in metallo con le medesime maggiorazioni previste per i colori di fascia 2 (da pag. 495 a pag. 501 e pag. 561)

# ALTERNA SCORREVOLE

## WARDROBES WITH SLIDING DOORS – ALTERNA

### ALTEZZE HEIGHTS

comprensiva di piedino regolabile da 0.6 a 2.5 cm adjustable foot from 0.6 to 2.5 cm included

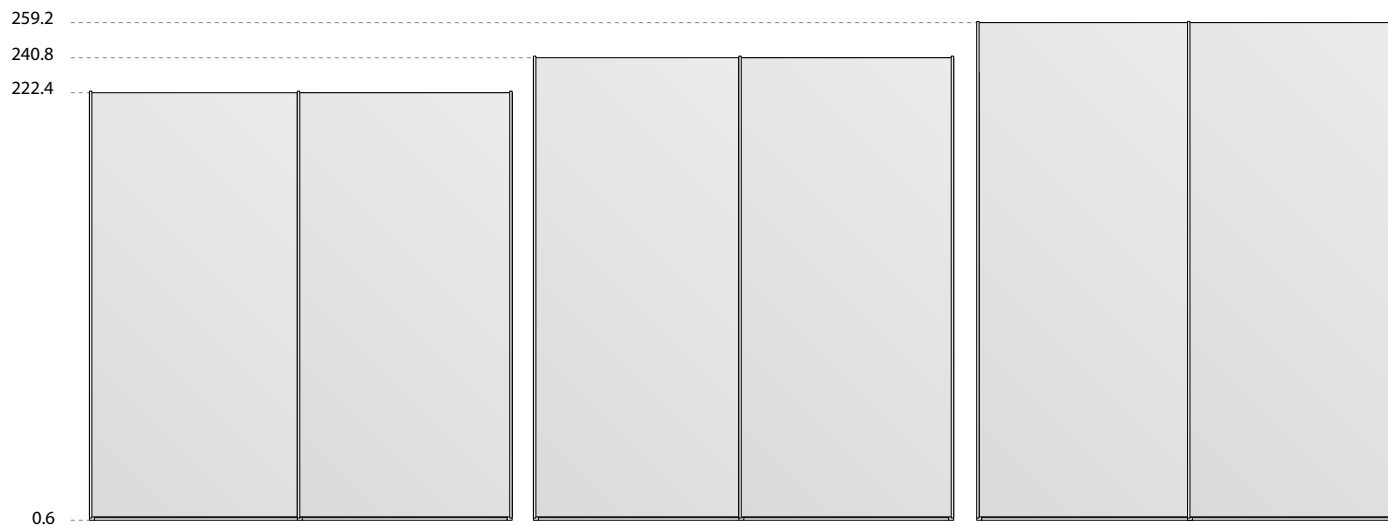

Altezze fianchi escluse di piedino 221.8 – 240.2 – 258.6 cm  
 Heights of sides without foot 221.8 – 240.2 – 258.6

### LARGHEZZE WIDTHS

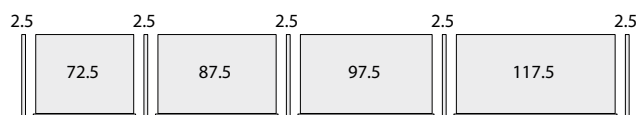

### PROFONDITÀ DEPTHS

PLANA – GOLA – MIXER – MIXER GLASS – DOUBLE – DOUBLE GLASS

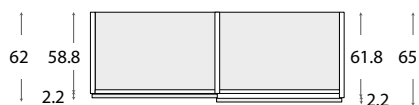

COMPASS – MONDRIAN

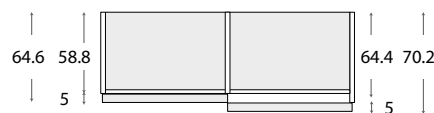

Terminale con appendino  
 End unit with hanging rail

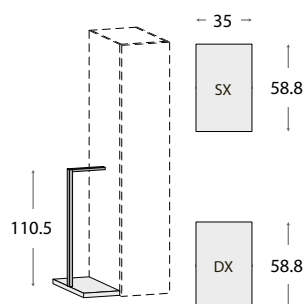

ALTERNA SCORREVOLE - ANTA PLANA  
PLANA SLIDING DOOR

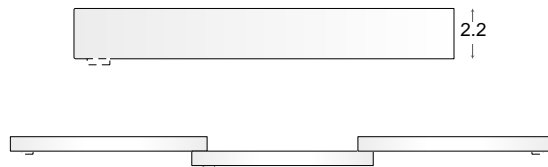
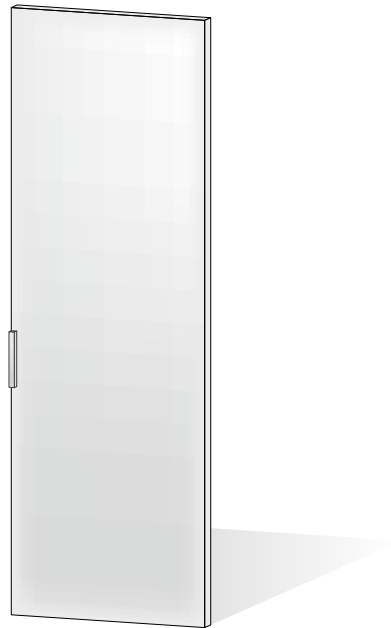

N.B.: Attrezzabile con maniglia RULER nei colori:

bianco talco - pomice - cashmere arena -selce -ottanio - agave - terracotta- opus calce - opus cemento - opus mattone - lava

N.B.: Can be fitted with RULER handle in the following colours:

talc white - pumice - cashmere - arena - flint - octane - agave - terracotta - opus lime - opus concrete - opus brick - lava

Attrezzabile con maniglia PLAN nei colori: Bianco talco – 0 chimico – Brunito

Can be fitted with PLAN handle in the following colours: Talc white – 0 finish – Burnished

ALTERNA SCORREVOLE - ANTA GOLA  
GOLA SLIDING DOOR

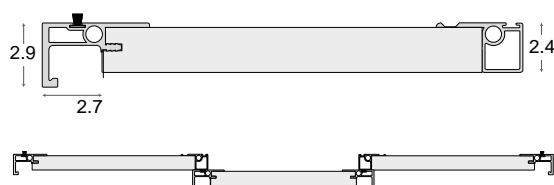

CARATTERISTICHE TECNICHE

L'anta scorrevole Gola è composta da:

– pannello melaminico in agglomerato di legno Sp. 2.2 cm

– Finitura profilo Gola

bianco talco - pomice - cashmere - arena -selce -ottanio - agave - terracotta- opus calce - opus cemento - opus mattone - brunito - lava

– dotata di dispositivo raddrizza-anta

– con sistema di scorrimento ammortizzato di serie in apertura e chiusura

TECHNICAL CHARACTERISTICS

Gola sliding door composed of:

– wood agglomerate melamine panel Th. 2.2 cm

– Gola profile finish

talc white - pumice - cashmere - arena - flint - octane - agave - terracotta - opus lime - opus concrete - opus brick - burnished - lava

ALTERNA SCORREVOLE - ANTA MIXER  
MIXER SLIDING DOOR

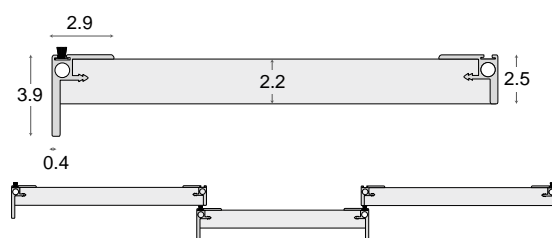
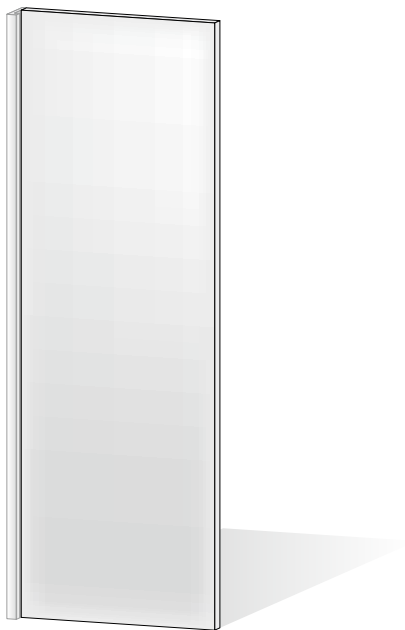

CARATTERISTICHE TECNICHE

L'anta scorrevole Mixer è composta da:

– pannello melaminico in agglomerato di legno Sp. 2.2 cm

– Finitura profilo Mixer

bianco talco - pomice - cashmere - arena -selce -ottanio - agave - terracotta- opus calce - opus cemento - opus mattone - brunito - lava

– dotata di dispositivo raddrizza-anta

– con sistema di scorrimento ammortizzato di serie in apertura e chiusura

TECHNICAL CHARACTERISTICS

Mixer sliding door composed of:

– wood agglomerate melamine panel Th. 2.2 cm

– Mixer profile finish

talc white - pumice - cashmere - arena - flint - octane - agave - terracotta - opus lime - opus concrete - opus brick - burnished - lava

– fitted with straighten-door device.

– with standard soft-close sliding system

ALTERNA SCORREVOLE - ANTA MIXER GLASS  
MIXER GLASS SLIDING DOOR

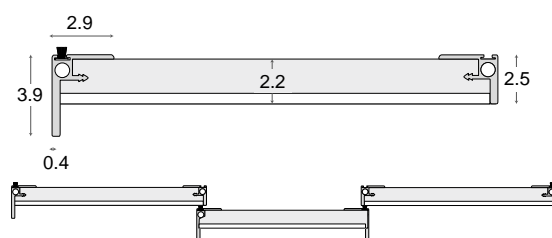

CARATTERISTICHE TECNICHE

L'anta scorrevole Mixer glass è composta da:

– pannello melaminico in agglomerato di legno Sp. 1.8 cm e vetro 0.4 cm con profili verticali in alluminio con finitura interna SESAMO – NOCE

– Finitura profilo Mixer:

bianco talco - pomice - cashmere - arena -selce -ottanio - agave - terracotta- opus calce - opus cemento - opus mattone - brunito - lava

– dotata di dispositivo raddrizza-anta

– con sistema di scorrimento ammortizzato di serie in apertura e chiusura

Finitura vetro:

– Specchio argentato o bronzato

– Vetro laccato lucido o opaco

TECHNICAL CHARACTERISTICS

Mixer sliding door composed of:

– wood agglomerate melamine panel Th. 1.8 cm and glass 0.4 cm with vertical aluminium profiles with internal finish SESAME – WALNUT

– Mixer profile finish:

talc white - pumice - cashmere - arena - flint - octane - agave - terracotta - opus lime - opus concrete - opus brick - burnished - lava

– fitted with straighten-door device.

– with standard soft-close sliding system

Glas finish:

– Bronzed or silver mirror

– Matt or glossy lacquered glass

# ALTERNA SCORREVOLE - DOUBLE DOUBLE SLIDING DOOR

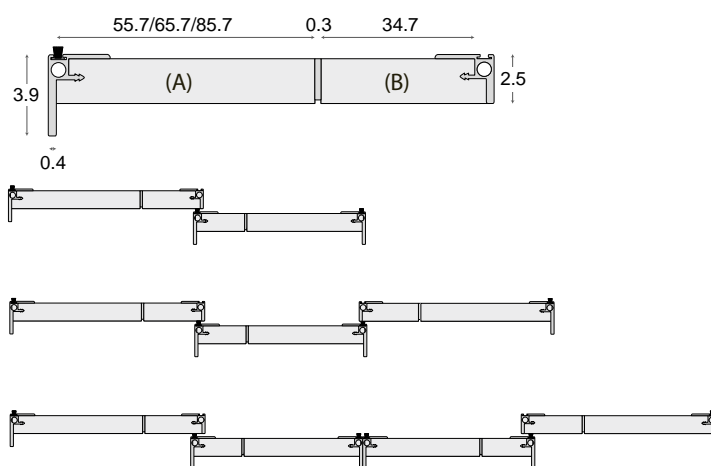
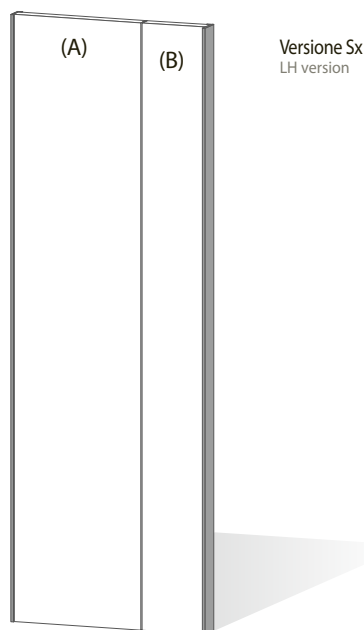

## CARATTERISTICHE TECNICHE

L'anta scorrevole Double pannello è composta da:

- pannello in melaminico in agglomerato di legno Sp. 2.2 cm
- Finitura profilo Double

bianco talco - pomice - cashmere - arena -selce -ottanio - agave - terracotta- opus calce - opus cemento - opus mattone - brunito - lava

- dotata di dispositivo raddrizza-anta

- con sistema di scorrimento ammortizzato di serie in apertura e chiusura

## TECHNICAL CHARACTERISTICS

Panel Double sliding door composed of:

- wood agglomerate melamine panel Th. 2.2 cm
- Double handle finish

talc white - pumice - cashmere - arena - flint - octane - agave - terracotta - opus lime - opus concrete - opus brick - burnished - lava

- fitted with straighten-door device.

- with standard soft-close sliding system

ALTERNA SCORREVOLE - DOUBLE GLASS  
DOUBLE GLASS SLIDING DOOR

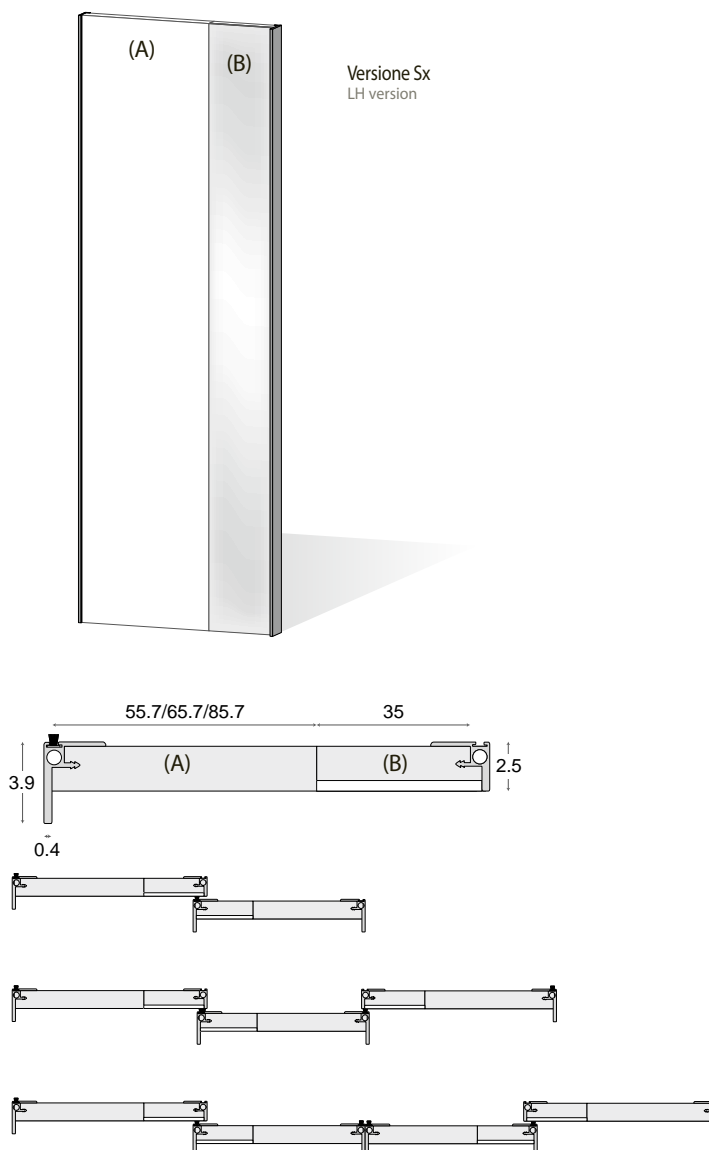

CARATTERISTICHE TECNICHE

L'anta scorrevole Double glass pannello è composta da:

- pannello in melaminico in agglomerato di legno Sp. 2.2 cm e pannello vetro (pannello 1.8 cm e vetro 0.4 cm)

- Finitura profilo Double

bianco talco - pomice - cashmere - arena -selce -ottanio - agave - terracotta- opus calce - opus cemento - opus mattone - brunito - lava

- dotata di dispositivo raddrizza-anta

- con sistema di scorrimento ammortizzato di serie in apertura e chiusura

L'anta è composta da due parti:

(A) solo pannello

(B) larga 35 cm con applicato:

- specchio argentato o bronzato
- vetro laccato lucido o opaco

TECHNICAL CHARACTERISTICS

Panel Double glass sliding door composed of:

- wood agglomerate melamine panel Th. 2.2 cm and glass panel (panel 1.8 cm and glass 0.4 cm)

- Double handle finish

talc white - pumice - cashmere - arena - flint - octane - agave - terracotta - opus lime - opus concrete - opus brick - burnished - lava

- fitted with straighten-door device.

- with standard soft-close sliding system

The door is in two parts:

(A) only panel

(B) W. 35 cm with applied:

- bronzed an silver mirror
- matt or glossy lacquered glass

ALTERNA SCORREVOLE - COMPASS  
COMPASS SLIDING DOOR

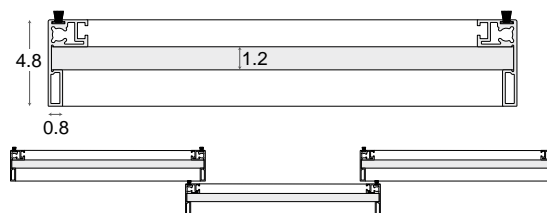

CARATTERISTICHE TECNICHE

L'anta scorrevole Compass è composta da:

- pannello melaminico in agglomerato di legno Sp. 1.2 cm
  - Cornice perimetrale Compass:
- Finiture: bianco talco - brunito
- dotata di dispositivo raddrizza-anta
  - con sistema di scorrimento ammortizzato di serie in apertura e chiusura

TECHNICAL CHARACTERISTICS

Compass sliding door composed of:

- wood agglomerate melamine panel Th. 1.2 cm
  - Compass perimetral frame:
- Finishes: talc white -burnished
- fitted with straighten-door device.
  - with standard soft-close sliding system

ALTERNA SCORREVOLE - MONDRIAN  
MONDRIAN SLIDING DOOR

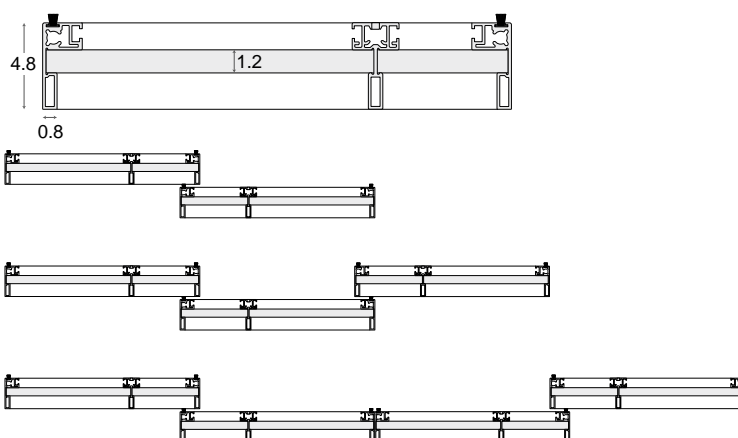

CARATTERISTICHE TECNICHE

L'anta scorrevole Mondrian è composta da:

- pannello melaminico in agglomerato di legno Sp. 1.2 cm, con possibilità di colorare le sezioni in modo differente.
- Cornice perimetrale Compass: con profilo verticale - orizzontale
- Finiture: bianco talco -brunito
- dotata di dispositivo raddrizza-anta
- con sistema di scorrimento ammortizzato di serie in apertura e chiusura

TECHNICAL CHARACTERISTICS

Mondrian sliding door composed of:

- wood agglomerate melamine panel Th. 1.2 cm, with the possibility to use different colours on different sections.
- Compass perimetral frame: with vertical-horizantal profile
- Finishes: talc white -burnished
- fitted with straighten-door device.
- with standard soft-close sliding system

DIMENSIONI PANNELLI

